

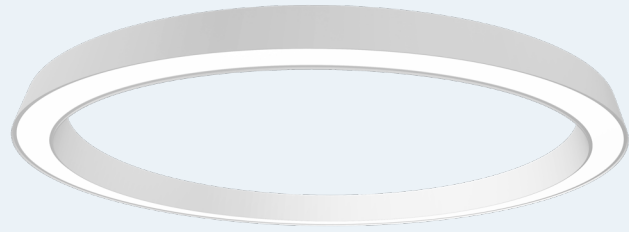

# Compass Series | COML-24-DI

Date	Notes
Project	
Type	Qty

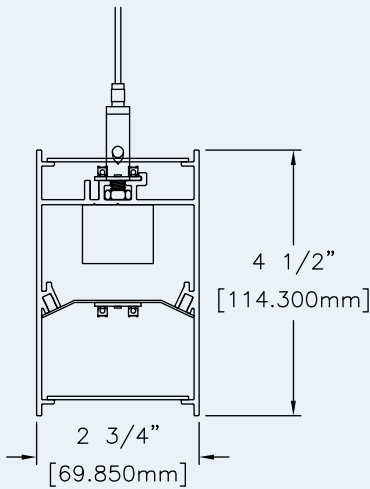

## Features

- Custom-rolled extruded aluminum housing.
- LED optimized optics for smooth illumination along entire lens.
- Suspension mount for any ceiling type. Creates architectural rings of light.
- High efficiency programmable driver for custom lumen packages. 0-10V dimming to 1% standard.
- High efficacy LEDs in 80 or 90 CRI; two or three channel tunable white; five channel tunable color.

## Ordering Guide

MODEL	OPTICS	CCT <sup>1</sup>	LUMENS <sup>2</sup>	DIAMETER <sup>3</sup>	MOUNTING <sup>4</sup>	FINISH	OPTIONS
<b>COML-24-DI</b>	<b>DP</b>						
COML-24-DI Direct/Indirect	DP = Diffuse Polycarbonate w/clear acrylic dust covers (lay-in). 2 ft, 3 ft, and 4 ft diameters include a one piece lens. All other diameters consist of multiple lenses that match their respective section size and count.	27 = 2700K 80CRI 30 = 3000K 80CRI 35 = 3500K 80CRI 40 = 4000K 80CRI 50 = 5000K 80CRI  For 90CRI add '9' prefix. Ex: 940 = 4000K @ 90 CRI  <b>TUNABLE WHITE<sup>1</sup></b> See all options page 4.  Please consult factory, not all options available or integral depending upon fixture diameter.	See table page 2 for lumen packages for all diameters.  Consult factory for custom lumen packages.  All values nominal.	2 = 2 ft 3 = 3 ft 4 = 4 ft 5 = 5 ft 6 = 6 ft 8 = 8 ft 10 = 10 ft 12 = 12 ft 16 = 16 ft 20 = 20 ft	AC = Aircraft Cable  PD = Pendant Stem  ACM = Mono Point (2'-5' only)	W = White CC = Custom Color  AMW = Anti-Microbial White	<b>DIMMING DRIVERS</b> DIM10 = 0-10V (1%) - <b>Standard</b> DIMSR = 0-10V (5.0%) Sensor Ready DIMST = Step Dimming (40%/100%) DALI = DALI (5.0%)  <b>LUTRON™ DIMMING DRIVERS</b> LDE1 = Hi-Lume™ 1% EcoSystem™ LDE5 = 5-Series 5% EcoSystem™ L3DA3W = Hi-Lume™ 1% 3-Wire LTEA2W = Hi-Lume 1% 2-Wire 120V  <b>SENSORS &amp; CONTROLS</b> ESN = Philips™ EasySense CAS = Casambi Bluetooth control  <b>EMERGENCY</b> EMC = Emergency Circuit GTD = Generator Transfer Device EPC4 = 4W Emergency Battery Pack EPC7 = 7W Emergency Battery Pack EPC10 = 10W Emergency Battery Pack EPC12 = 12W Emergency Battery Pack  Please consult factory, not all options available or integral depending upon fixture diameter.

<sup>1</sup>Tunable white, tunable color and RGB/W options detailed on page 4.

<sup>2</sup>Delivered Lumens are Standard Output (SO) and Low Output (LO) at 80+CRI 4000K CCT. Use the following multiplier to estimate delivered lumens at other CCTs: 2700K = 0.94, 3000K = 0.96, 3500K = 0.98, 5000K = 1.02. See page 2 for photometry.

<sup>3</sup>See page 2 for actual dimensions per diameter, and section information.



### Size Options & Odering Instructions

The Compass Series may be ordered in a variety of standard diameters outlined below. Diameters from 2'-5' consist of a single fully welded assembly shipped in a single carton. Diameters of 6'-20' consist of sections that ship as a set in multiple cartons. For all sizes use only the **SIZE ORDER CODE** below. Do not order sections separately.

Mounting Diameters 2'-5' may be ordered with either a 3-into-1 monopoint aircraft assembly or parallel aircraft cables or pendant stems. Diameters 6'-20' may ordered with only parallel aircraft cables or pendant stems. See following page for suspension details. All sizes may also be surface ceiling mounted or recessed in plaster ceilings (trimless only).

SIZE ORDER CODE	NOMINAL DIAMETER	ACTUAL DIAMETER	SECTION COUNT	SECTION LENGTH	MOUNTING POINTS	LO LUMENS DIR/ND	LO WATTS DIR/ND	LO EFFICACY DIR/ND	SO LUMENS DIR/ND	SO WATTS DIR/ND	SO EFFICACY DIR/ND
2	2'	23"	1	23"	3	5,690	52	115	7,590	70	109
3	3'	35"	1	35"	3	9,400	86	115	12,540	115	109
4	4'	47"	1	47"	3	13,110	120	115	17,490	160	109
5	5'	60"	1	60"	3	17,820	162	115	23,760	216	109
6	6'	72"	2	72"	4	21,285	193	115	28,380	257	109
8	8'	96"	3	83 1/8"	6	27,473	250	115	36,630	334	109
10	10'	120"	4	84 7/8"	8	35,640	323	115	47,520	431	109
12	12'	144"	6	72"	12	43,065	391	115	57,420	522	109
16	16'	192"	6	96"	12	58,410	532	115	77,800	709	109
20	20'	240"	8	91 7/8"	16	73,260	668	115	97,680	890	109

Standard fully assembled, one-piece housing and lens size shown immediately below.

COML-24-DI-2'

COML-24-DI-3'

COML-24-DI-4'

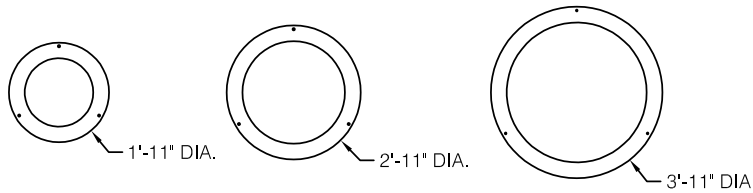

For diameters larger than 5' the section count and length is shown below.

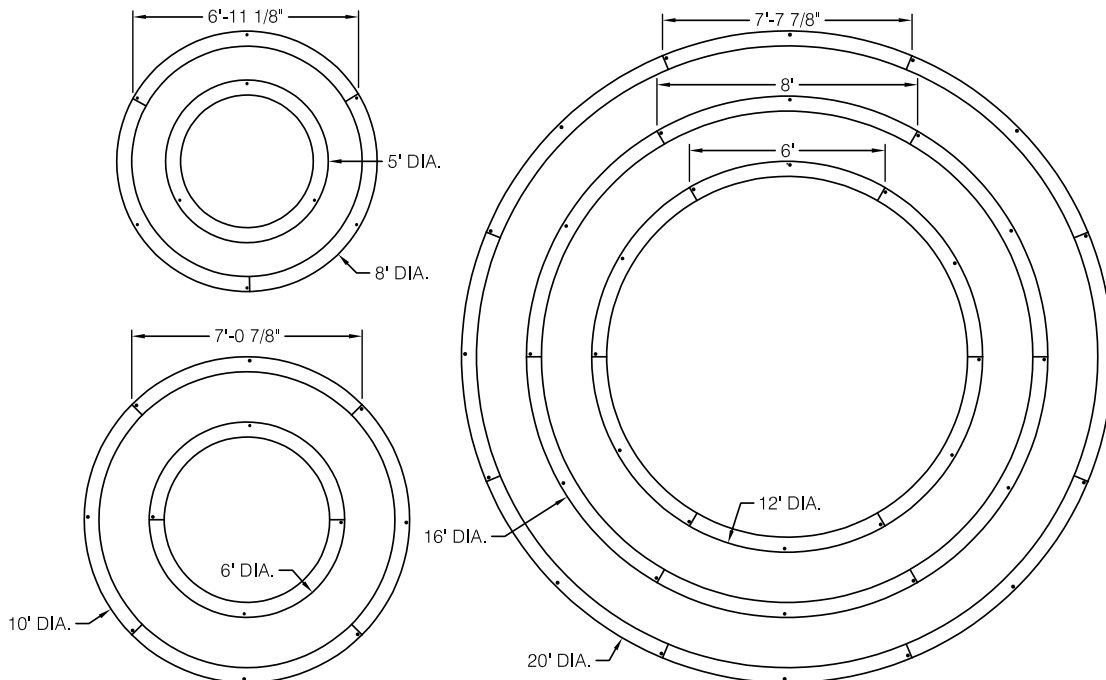

## Standard Suspensions

Standard suspension options include adjustable self-locking aircraft cables (AC), a 3-into-1 monopoint (ACM) and rigid pendant stems (PD). AC assembly is 48" x 1/16" with a 5" feed canopy and 2" suspension canopies. 60" 18 gauge power and 22 gauge dimming control SJT feed.

PD assemblies are 5/8" dia. (or 3/8" IP) hollow stem for power feed by others, 24" is standard. Consult factory for longer suspension lengths and other mounting options.

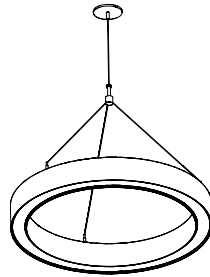

**ACM** = Mono Point  
(2'-5' diameter only)

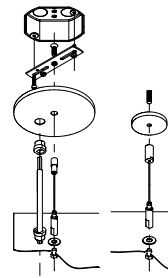

**AC** = Aircraft Cable  
(All diameters)

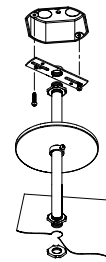

**PD** = Pendant Stem  
(All diameters)

## Specifications

**CONSTRUCTION** Extruded aluminum housing, w/prefinished steel internal components.

**REFLECTOR** Extruded aluminum finished in highly reflective baked white enamel with pre-finished reflective LED tray.

**OPTICS** LED optimized diffuse polycarbonate (DP) lens standard.

**LED** LED modules in 30/35/40 & 50K CCT, 80/90CRI. Lumen maintenance minimum  $L_{70}$  = 50,000 hours. 3 SDCM color consistency.

**DRIVER** Standard driver is Class 2 AOC 0-10V to 1%, 120/277V input, PF > 90%, THD < 20 @ 120V. Additional dimming protocols available. All drivers prewired from factory for connection to control system (by others). Field replaceable.

**MOUNTING** Standard options include adjustable self-locking aircraft cables (AC), 3-into-1 monopoint (ACM) and rigid pendant stems (PD). AC assembly is 48" x 1/16" with a 5" feed canopy and 2" suspension canopies. 18 gauge power and 22 gauge dimming control SJT feed.

**FINISH** Housing and components finished in baked white enamel. Canopies and pendant stems are white enamel unless otherwise specified.

**CERTIFICATION** Luminaires are cETLus listed conforming to UL STD. 1598 and certified to CSA STD C22.2 NO. 250.0. Suitable for dry & damp locations. Union Made in the United States of America. I.B.E.W. RoHS compliant.

Day-O-Lite offers a variety of tunable white and tunable color options for a range of human centric applications and budgets. It is recommended that a recognized authority on the benefits and best practices of tunable white be consulted prior to specification. As a rule, fewer channels will provide a basic level of performance for budget conscious applications. Conversely, an increased number of channels, a wider CCT range, higher CRI and more precise color consistency may be more appropriate depending on the application and desired results.

### HOW TO SPECIFY

Select from the various channel/control options below and insert desired **Ordering Code** into the **COLOR TEMP** column of the Ordering Guide on page 1. No need to add a dimming option as the codes include the chosen protocol.

### 2-CHANNEL TUNABLE WHITE OPTIONS

2700K - 6500K CCT range  
1000L/ft LED modules @ 4000K  
80+ CRI w/3SDCM color accuracy  
10W/ft. nominal power

#### Ordering Codes

**2DIM10** for 0-10V control  
**2DALI** for DALI control  
**2DMX** for DMX control  
**2PSQ** for Lutron Quantum control  
**2SNS** for control via Signify SNS sensors  
**2CAS** for control via Casambi BLE wireless devices

### LEGRAND BLANCO MULTI-CHANNEL OPTIONS

#### Blanco-2

Blanco-2 mixes two channels of white LEDs to approximate the blackbody curve for tunable white applications. CCT and intensity may be adjusted with controls by others.

3000K-5000K CCT range  
1000L/ft LED modules @ 4000K  
90+ CRI w/2SDCM color accuracy  
10W/ft. nominal power

#### Ordering Codes

**B2DLM** for DLM control

#### Blanco-3

Blanco-3 mixes three channels of white LEDs across a wider range of color temperatures for more demanding tunable white applications. CCT and intensity may be adjusted with controls by others.

2700K-6500K CCT range  
1000L/ft. LED modules @ 4000K  
90+ CRI w/SDCM color accuracy  
10W/ft. nominal power

#### Ordering Codes

**B3DLM** for DLM control

### RGB & RGBW TUNABLE COLOR

RGB = Red, Green, Blue color mixing LEDs  
RGB/W = Red, Green, Blue + White of chosen CCT  
Dimming from 100% to 1%.  
90+ CRI w/3SDCM color accuracy  
10W/ft. nominal power

#### Notes:

RGB requires an RGB DMX or DALI controller (by others)

RGBW requires an RGBW DMX or DALI controller (by others)

All channels on one driver is standard, if isolating the White from the RGB channels is desired please consult factory.

RGB and RGBW are not recommended for tunable white applications.

#### Ordering Codes

**RGB** for DMX control  
**RGB27** for DMX control w/2700K white  
**RGB30** for DMX control w/3000K white  
**RGB35** for DMX control w/3500K white  
**RGB40** for DMX control w/4000K white  
**RGB50** for DMX control w/5000K white  
**RGB65** for DMX control w/6500K white  
Add Suffix **DAL** for DALI Control to codes above.

### 5-CHANNEL TUNABLE WHITE AND COLOR

RGBWW = Red, Green, Blue, Warm White, Cool White.  
Consult factory for RGBWW tunable white/color options.

<sup>1</sup>Please consult factory, not all options available or integral depending upon fixture diameter.

Day-O-Lite makes no claims as to the psychological or physiological efficacy of the white color tuning options offered herein.