

Date		Notes
Project		
Type	Qty	

### Features

- Durable extruded aluminum housing.
- LED optimized optics for smooth, efficient illumination.
- Individual fixtures, continuous rows or custom patterns.
- Programmable driver for custom lumen packages.
- 0-10V dimming to 1% standard. Dim-to-off available.
- DMX, Lutron and DALI protocols also available.
- Sensor Ready for wireless Smart Lighting Solutions.
- 80/90CRI, Tunable White and RGB available.
- Bios SkyBlue™ circadian solutions available.

**Declare** Red List Approved.

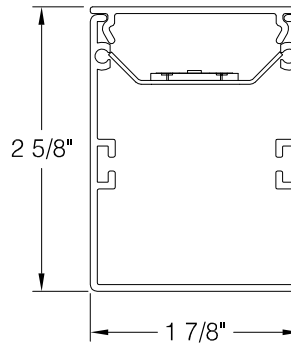

### Ordering Guide



MODEL	OPTICS	LED <sup>1</sup>	LUMENS <sup>2</sup>	LENGTH	MOUNTING <sup>3</sup>	FINISH	OPTIONS
<b>PRFL-22-I</b>							
<b>PRFL-22-I</b> Indirect	<b>FL</b> = Frosted Acrylic Flush Lens	<b>STATIC WHITE</b> 27 = 2700K 80CRI 30 = 3000K 80CRI 35 = 3500K 80CRI 40 = 4000K 80CRI 50 = 5000K 80CRI  <b>BIOS SkyBlue</b> Circadian solutions  <b>TUNABLE 2-Channel</b> 2700K-6500K Fixed CCT Range 2DIM10 = for 0-10V 2DMX = for DMX 2ESN = for Philips 2CAS = for Casambi 2LUT = for Lutron  <b>TUNABLE 3-Channel</b> 1800K-6500K 92 CRI Selectable CCT Range 3DIM10 = for 0-10V  <b>DIM-TO-WARM</b> DTW = Dim-to-Warm (2700K-6500K) 0-10V 3DTW = Dim-to-Warm (1800K-6500K) 0-10V  <b>RGB+WHITE</b> RGB = RGB RGBW = RGBW DMX driver remote mount only.	<b>STANDARD</b> <b>LO</b> = 565/ft (5W/ft, 110LPW)  <b>SO</b> = 741/ft (8W/ft, 110LPW)  <b>CUSTOM</b> Specify < HO.	2 = 2 ft 3 = 3 ft 4 = 4 ft 5 = 5 ft 6 = 6 ft 7 = 7 ft 8 = 8 ft For other enter row length (48 = 48 ft)	<b>AC</b> = Aircraft Cable  <b>PD</b> = Pendant Stem  <b>S</b> = Surface  <b>WM</b> = Wall Mount	<b>W</b> = White CC = Custom Color AMW = Anti Microbial White	<b>DIMMING DRIVERS</b> <b>DIM10</b> = 0-10V (1%) - Standard DTO = 0-10V (Dim-to-Off) DIMST = 0-10V Step Dimming 347 = 0-10V (347V) DIMSR = DALI Sensor Ready (5.0%) DALI = DALI (5.0%) DMX = DMX (remote mount only)  <b>LUTRON™ DIMMING DRIVERS</b> <b>LDE1</b> = Hi-Lume 1% EcoSystem LD2 = Digital 1% (DALI-2) L3DA3W = Hi-Lume 1% 3-Wire  <b>SENSORS &amp; CONTROLS<sup>4</sup></b>  <b>EMERGENCY &amp; BATTERY<sup>5</sup></b> GTD = Generator Transfer Device EMC = Emergency Circuit EPC4 = 4W Integral Battery EPC6 = 6.5W Integral Battery EPC10 = 10W Integral Battery EPC12 = 12W Integral Battery  <b>WIRING &amp; OTHER</b> FWH = Flexible Wiring Harness  <i>Consult factory on Options. Not all are integral to PRFL-22.</i>

<sup>1</sup>All LED, BIOS, Tunable White, DTW, and RGB options and Ordering Codes page 2.

<sup>2</sup>Lumens at 80CRI, 3500K, FL lens. Photometry page 5.

<sup>3</sup>See page 5 for mounting option details.

<sup>4</sup>All Sensor & Control options page 2.

<sup>5</sup>EPC6 is standard unless otherwise specified. EPC not for DMX drivers.

**BAA** letter of compliance available at [www.dayolite.com](http://www.dayolite.com).

**RS** 10 Day Rapid Ship options in **blue**. Details page 6.

**LED, BIOS, Sensor & Control Ordering Codes**

**LED**

**Static White**

30 = 3000K 80 CRI  
 35 = 3500K 80 CRI  
 40 = 4000K 80 CRI  
 50 = 5000K 80 CRI

927 = 2700K 90 CRI  
 930 = 3000K 90 CRI  
 935 = 3500K 90 CRI  
 940 = 4000K 90 CRI

**Tunable<sup>1</sup> 2-Channel**

2700K-6500K 80 CRI  
 Fixed CCT Range

2DIM10 = 0-10V  
 2DMX = DMX 80  
 2CAS = Casambi Wireless  
 2ESN = Philips EasySense  
 2LUT = Lutron (LD2)

92DIM10 = 0-10V 90 CRI  
 92DMX = DMX 90 CRI  
 92CAS = Casambi Wireless 90 CRI  
 92ESN = Philips EasySense 90 CRI  
 92LUT = Lutron (LD2) 90 CRI

**Tunable<sup>1</sup> 3-Channel**

1800K-6500K 92 CRI  
 Selectable range CCT (factory set)

3DIM10 = 0-10V Dimming

**Dim-to-Warm<sup>2</sup>**

DTW = 6500K-2700K 80 CRI  
 9DTW = 6500K-2700K 90 CRI

3DTW = 6500K-1800K 92 CRI  
 Selectable range CCT (factory set).  
 To specify write in the desired range; eg. 65/18 = 6500K-1800K, or 57/22 = 5700K-2200K.

**RGB<sup>3</sup>**

RGB = RGB

**Single Color**

RED = Red  
 BLU = Blue  
 GRN = Green  
 AMB = Amber

**BIOS SkyBlue**

BIOS SkyBlue biological technology brings the benefits of blue skies inside. BIOS SkyBlue is the only spectrally optimized circadian solution to target the region that drives wellness benefits including: increased alertness, enhanced productivity, better mood, and better sleep. More information may be found at [www.bioslighting.com](http://www.bioslighting.com) or by contacting Day-O-Lite directly. All options for 0-10V control.

**BIOS Biological Static**

For daytime applications. BIOS Static Biological LED features key BIOS SkyBlue (490nm) for maximum daytime circadian impact.

B30 = 3000K  
 B35 = 3500K  
 B40 = 4000K

**BIOS Biological Dynamic White**

Designed to transition from daytime to evening in a dim-to-warm protocol. The daytime CCT includes full BIOS SkyBlue (490nm) for maximum daytime circadian impact, while the evening spectrum removes BIOS SkyBlue for minimal circadian stimulus after hours.

B30D = 3000K-2700K  
 B35D = 3500K-3000K  
 B40D = 4000K-3500K

**BIOS Biological Tunable White**

Designed to transition from daytime to evening in a tunable white protocol. The daytime CCT includes full BIOS SkyBlue (490nm) for maximum daytime circadian impact, while the evening spectrum removes BIOS SkyBlue for minimal circadian stimulus after hours.

B30T = 3000K-2700K  
 B35T = 3500K-2700K  
 B40T = 4000K-2700K

**Sensors & Controls**

**Sensors\***

AVO = Avi-On Occ/Day  
 AVM = Avi-On Occ (Microwave)  
 AVN = Avi-On Node  
 BNV = BubblyNet Occ/Day  
 LEG = Legrand Occ/Day  
 ANW = Lutron Athena Occ/Day  
 VIVE = Lutron Vive Occ/Day  
 NLT = Acuity nLight Occ/Day  
 NXC = Current NX Occ/Day  
 ESN = Philips EasySense Occ/Day  
 WWL = Cooper WaveLinx Occ/Day

Sensors and control options to be commissioned wirelessly in the field by qualified controls personnel with applicable apps (by others).

**Wireless Control**

CAS = Casambi

**Other Options**

Other sensor and wireless control options are available. Contact factory for details.

\*Sensors for remote mount only.

<sup>1</sup>Tunable white may be controlled by a number of dimming protocols as shown. 2-Channel has a fixed range of 2700K-6500K. 3-Channel has a maximum range of 1800K-6500K, but other sub-ranges may be specified. 3-Channel Tunable White has a third diode to more closely approximate the black body curve in the mid CCT ranges. Contact Day-O-Lite for details.

<sup>2</sup>Dim-to-Warm mimics incandescent dimming by warming the CCT from 6500K-2700K (2DTW) or 6500K-1800K (3DTW) as light levels are dimmed.

<sup>3</sup>All RGB options for DMX control (by others). 80 CRI standard.

### Individual Fixtures & Continuous Rows

NOMINAL LENGTH	ACTUAL LENGTH	SUSP. 1 O.C.	SUSP. 2 O.C.	SUSP. 3 O.C.
4'	3'-11"	45"		
8'	7'-7 1/2"	89 1/2"		
12'	11'-6 1/2"	89 1/2"	47"	
16'	15'-3"	89 1/2"	91 1/2"	
20'	19'-2"	89 1/2"	91 1/2"	47"
24'	22'-10 1/2"	89 1/2"	91 1/2"	91 1/2"

Individual fixtures and rows are continuously illuminated and joined with included aligner brackets and hardware. Power feed locations and mounting locations are shown below.

Continuous rows longer than 8' and patterns, including EPC/EMC and sensor locations must be approved prior to manufacturing. See following page to specify patterns.

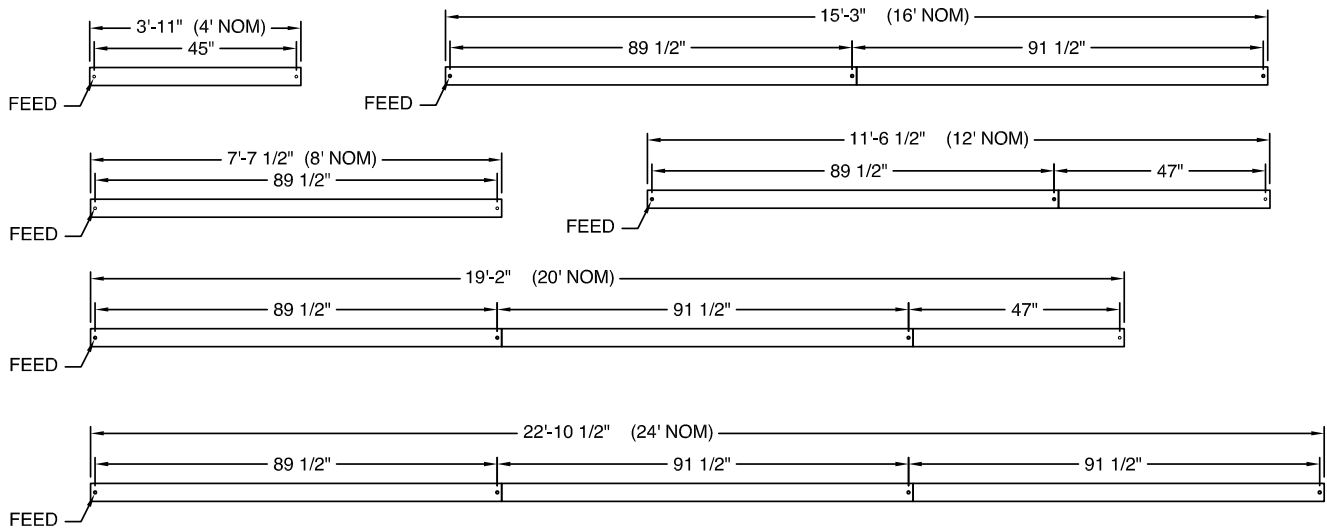

### Emergency & Sensor Locations

**EPC** will control entire length of individual fixtures. Individual fixtures of differing lengths will deliver the same lumens under EPC power (a 4' fixture will deliver the same total lumens over half the length of an 8' fixture). **EMC** controlled individual fixtures will deliver lumens per foot as originally specified, unless dimmed at time of power loss. Consult factory for EMC dimming override device.

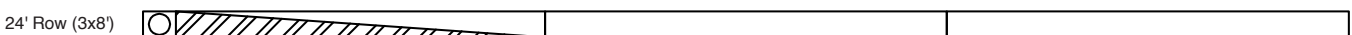
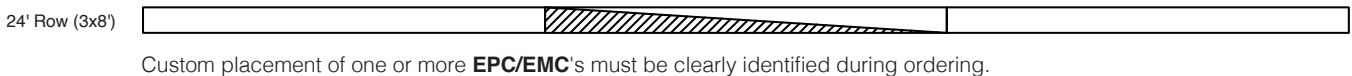
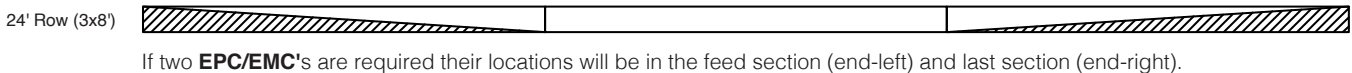
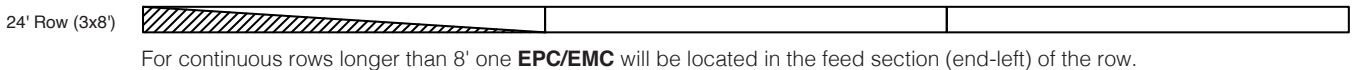

**SENSORS** for rows will control the feed section (end-left) of the row. Sensors can control more than an 8' section within a row. Consult factory for sensor/section options, or for multiple sensors in a continuous row.

## Pattern Guide

Profile may be specified in patterns of virtually any configuration. All patterns and corners are continuously illuminated and joined with included aligner brackets and joining hardware. See examples below for pattern suggestions. Day-O-Lite's custom manufacturing capabilities allow the specification of custom angled connectors to make arbitrary patterns possible. (See ILX example below).

All corners and connectors are fully welded to ensure correct dimensions and "square" joinery when assembled.

## How to Specify

1. Submit your pattern to Day-O-Lite in dimensioned CAD file or submit a fully dimensioned PDF file.
2. If EPC/EMC or Sensors are to be included their location needs to be clearly noted.
3. Day-O-Lite will design your pattern to as close as is nominally possible given standard LED module lengths, including connectors.
4. Day-O-Lite will supply a detailed drawing for approval with final dimensions. All patterns must be approved prior to manufacture.

## Pattern Examples

## Illuminated Connectors

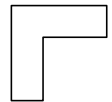
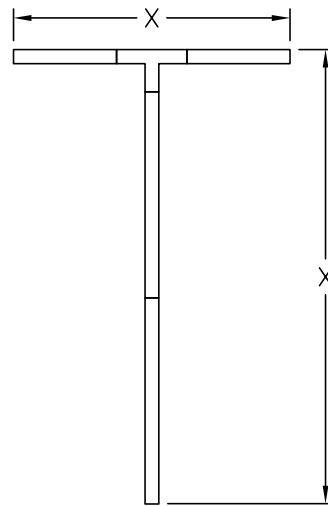
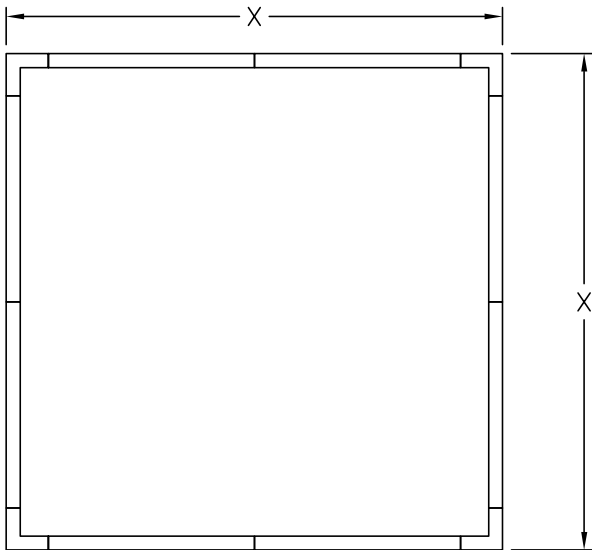

**ILC2 = 90° Corner**

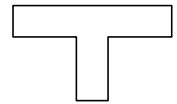

**ILC3 = 90° Tee**

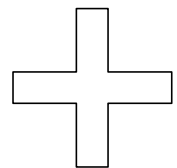

**ILC4 = 90° Cross**

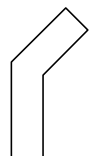
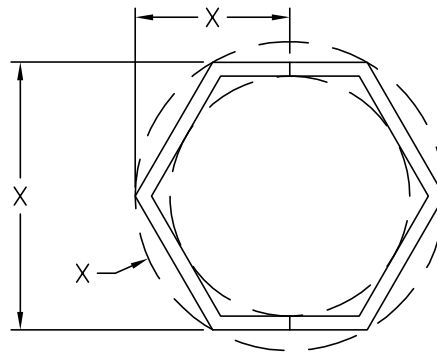
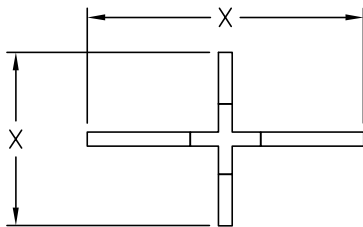

**ILCX = X° Custom**

### Optics

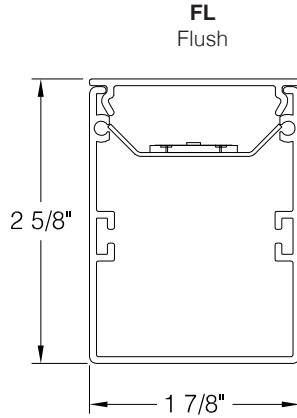

### Mounting

Standard suspension options include adjustable self-locking aircraft cables (AC) and rigid pendant stems (PD). AC assembly is 48" x 1/16" with a 5" feed canopy and 2" suspension canopies. 60" 18 gauge power and 22 gauge dimming control SJT feed. PD assemblies are 5/8" dia. (or 3/8" IP) hollow stem for power feed (by others); 24" is standard. Consult factory for longer suspension lengths and other mounting options.

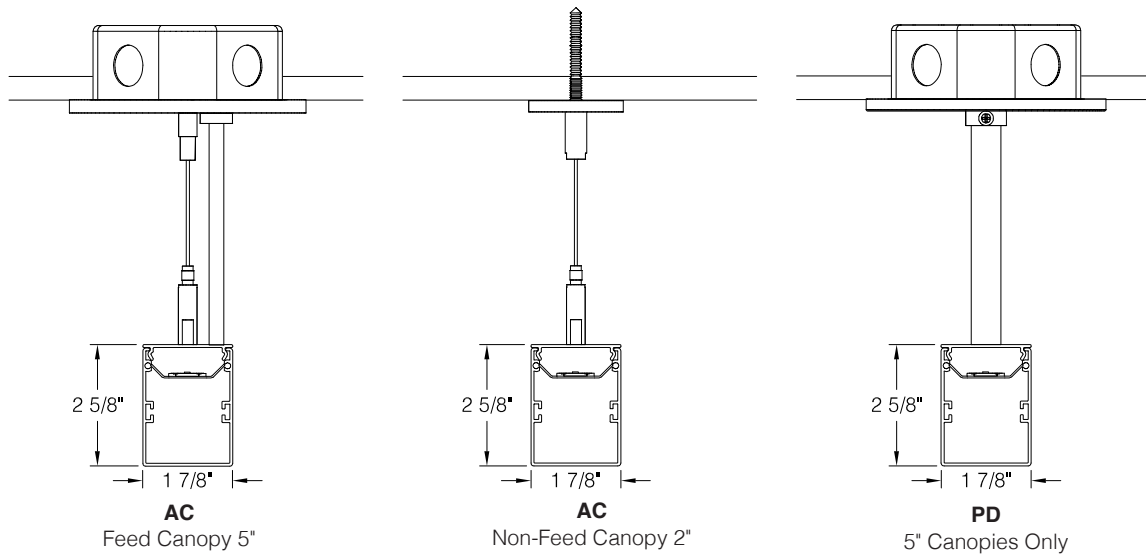

**AC-PF** = Replacement Power Feed w/cable Kit w/5" canopy.  
**AC-NF** = Replacement Non/Feed Kit w/2" canopy.  
 Consult factory for custom lengths and either 5 or 6 wire power feeds.

### Photometry

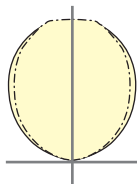

PRFL-22-I-**FL**-40-**LO**-4  
 Flush Lens  
 3500K CCT  
 WATTS: 27  
 LUMENS: 2260  
 LPW: 110

PRFL-22-I-**FL**-40-**SO**-4  
 Frosted Lens  
 3500K CCT  
 WATTS: 27  
 LUMENS: 2963  
 LPW: 110

4000K @ 80CRI, 4', FL lens.

Use the following multipliers for other CCTs: 2700K x 0.96, 3000K x 0.98, 4000K x 1.02, 5000K x 1.03. IES files @ [www.dayolite.com](http://www.dayolite.com)

## Specifications

**CONSTRUCTION:** Extruded aluminum housing, 20 gauge cold rolled steel internal components.

**REFLECTOR:** Highly reflective baked white enamel with pre-finished reflective LED tray.

**OPTICS:** Frosted acrylic, 1" and 2" drop lens (square) and 1" and 2" drop lens (round).

**LED:** Static white LED modules in 27/30/35/40 & 50K CCT, 80/90CRI. Lumen maintenance minimum  $L_{70}$  = 50,000 hours. 3 SDCM color consistency. BIOS SkyBlue, RGB, RGBW, RGBWW, Tunable White and Dim-to-Warm options available; field replaceable.

**DRIVER:** Standard driver is Class 2 AOC 0-10V to 1%, Dim-to-Off available. 120/277V input, PF > 90%, THD < 20 @ 120V. DMX, DALI & Lutron protocols available. All drivers prewired for connection to control system (by others), field replaceable.

**MOUNTING:** Standard options include adjustable self-locking aircraft cables, and rigid pendant stems. Aircraft cable assembly is 48" x 1/16" with a 5" feed canopy and 2" suspension canopies. 18 gauge power and 22 gauge dimming control SJT feed.

**FINISH:** Housing and components finished in baked white enamel. Canopies and pendant stems are white enamel unless otherwise specified. 5" feed canopy w/2" suspension canopies.

**CERTIFICATION:** cETLus listed conforming to UL STD. 1598 and certified to CSA STD C22.2 NO. 250.0. Suitable for dry & damp locations. Union Made in the United States of America, I.B.E.W., BAA compliant, Declare Red List Approved.

**LEGAL:** Day-O-Lite, a division of SCW Corporation. All rights reserved. The Day-O-Lite logo is a registered trademark of SCW Corporation. Actual product performance may differ due to end user environment, application and installation. Luminaires have been tested at 25° C ambient temperature. Consult Day-O-Lite for high-ambient conditions. Day-O-Lite reserves the right to change specifications without notice for product improvement.

---

## Rapid Ship Program

Rapid Ship products are estimated to ship 10 business days or less from the morning the order is received and confirmed. Linear rows will ship 10 business days or less from the day the layout drawings are approved. Orders confirmed and layouts approved after 12:00 p.m. Eastern Time are estimated to ship 10 days or less from the following business morning. Please refer to complete program Terms & Conditions at [www.dayolite.com](http://www.dayolite.com).

Rapid Ship options are limited to those highlighted in **blue** on the Ordering Guide. 400' max individual or continuous row allowed. Consult factory for additional information.