



# New Age Series | NASL-RND-3

Date	Notes
Project	
Type	Qty

## Features

- Steel housing with flat, convex or concave lenses.
- LED optimized optics for smooth, efficient illumination.
- Tamper resistant option w/polycarbonate lens available.
- Programmable driver for custom lumen packages.
- 0-10V dimming to 1% standard or Dim-to-Off.
- DMX, Lutron and DALI protocols also available.
- Sensor Ready for wireless Smart Lighting Solutions.
- 80/90CRI, Tunable White, RGBW & RGBWW.
- Bios SkyBlue™ circadian solutions available.
- Compatible with Armstrong® ceiling systems.

**Declare** Red List Approved.



Grid Ceiling Flat Lens.  
See page 3 for all lens and ceiling options.

## Ordering Guide



MODEL	OPTICS	CCT <sup>1</sup>	LUMENS <sup>2</sup>	SIZE	MOUNTING <sup>3</sup>	FINISH	OPTIONS
<b>NASL-RND-D</b>				<b>3</b>			
NASL-RND-D Direct	SI = Satin Ice Acrylic (Flat)  CX = Convex (white opal acrylic)  CC = Concave (white opal acrylic)	<b>STATIC WHITE</b> 27 = 2700K 30 = 3000K 35 = 3500K 40 = 4000K 50 = 5000K  <b>BIOS SkyBlue</b> Spectrally optimized circadian solutions.  <b>TUNABLE WHITE</b> (2700K-6500K) 2DIM10 = for 0-10V 2DMX = for DMX 2ESN = for Philips 2CAS = for Casambi 2LUT = for Lutron  <b>DIM-TO-WARM</b> DTW = Dim-to-Warm  <b>RGB &amp; WHITE</b> RGB = RGB RGBW = RGBW RGBWW = RGBWW (2700K-6500K)	<b>GRID CEILINGS</b> LO = 3975 (40W, 99LPW) SO = 5300 (54W, 98LPW) HO = 6600 (70W, 94LPW)  <b>DRYWALL CEILINGS</b> (Flange) LO = 5650 (61W, 92LPW) SO = 7500 (81W, 92LPW) HO = 9200 (101W, 91LPW)  <b>CUSTOM</b> Specify value < HO.	3 = 3'	G = Grid 15/16" T-Bar  MG = Mini Grid 9/16" T-Bar  SG = Slot Grid  SGF = Slot Grid Flush  XG = Interlude  XGF = Interlude Flush  TGF = Tegular Flush 15/16" T-Bar  XGF = Tegular Flush 9/16" T-Bar  F = Flange  <b>TAMPER RESISTANT<sup>6</sup></b> GTR = Grid FTR = Flange	W = White  CC = Custom Color  AMW = Anti-Microbial White	<b>DIMMING DRIVERS</b> DIM10 = 0-10V (1%) Standard DTO = 0-10V (Dim-to-Off) DIMST = 0-10V Step Dimming DIMSR = DALI Sensor Ready (5.0%) DALI = DALI (5.0%) DMX = DMX  <b>LUTRON™ DIMMING DRIVERS</b> LDE1 = Hi-Lume 1% EcoSystem LD2 = Digital 1% (DALI-2) L3DA3W = Hi-Lume 1% 3-Wire  <b>SENSORS &amp; CONTROLS<sup>4</sup></b> AVO = Avi-On Sensor AWNS = Lutron Athena Sensor ESN = EasySense Sensor CAS = Casambi Wireless Control  <b>EMERGENCY<sup>5</sup></b> EMC = Emergency Circuit GTD = Generator Transfer Device EPC4 = 4W Emergency Battery Pack EPC6 = 6.5W Emergency Battery Pack EPC10 = 10W Emergency Battery Pack EPC12 = 12W Emergency Battery Pack  <b>WIRING</b> FWH = Flexible Wiring Harness

<sup>1</sup>All LED, BIOS, Tunable White, DTW, and RGB/W options and Ordering Codes page 2.

<sup>2</sup>Lumens at 80CRI, 3500K, SI lens. Photometry page 4.

<sup>3</sup>See page 3/4 for all mounting options.

<sup>4</sup>All Sensor & Control options page 2. Sensors remote mount only.

<sup>5</sup>EPC6 is standard unless otherwise specified. EPC not for DMX drivers.

<sup>6</sup>Tamper resistant option includes polycarbonate lens secured with Torx screws.

**BAA** letter of compliance available at [www.dayolite.com](http://www.dayolite.com).

**LED, BIOS, Sensor & Control Ordering Codes****LED****Static White**

30 = 3000K 80 CRI  
 35 = 3500K 80 CRI  
 40 = 4000K 80 CRI  
 50 = 5000K 80 CRI

927 = 2700K 90 CRI  
 930 = 3000K 90 CRI  
 935 = 3500K 90 CRI  
 940 = 4000K 90 CRI

**Tunable White<sup>1</sup>**  
(2700K-6500K)

2DIM10 = 0-10V 80 CRI  
 2DMX = DMX 80 CRI  
 2CAS = Casambi Wireless 80 CRI  
 2ESN = Philips EasySense 80 CRI  
 2LUT = Lutron (LD2) 80 CRI

92DIM10 = 0-10V 90 CRI  
 92DMX = DMX 90 CRI  
 92CAS = Casambi Wireless 90 CRI  
 92ESN = Philips EasySense 90 CRI  
 92LUT = Lutron (LD2) 90 CRI

**Dim-to-Warm<sup>2</sup>**

DTW = 6500K-2700K 80 CRI  
 9DTW = 6500K-2700K 90 CRI

**RGB/W<sup>3</sup>**

RGB = RGB only  
 RGB27 = RGB w/2700K  
 RGB30 = RGB w/3000K  
 RGB35 = RGB W/3500K  
 RGB40 = RGB w/4000K  
 RGB50 = RGB w/5000K  
 RGBWW = RGB w/2700K-6500K

**Single Color**

RED = Red  
 BLU = Blue  
 GRN = Green  
 AMB = Amber

**BIOS SkyBlue**

BIOS SkyBlue biological technology brings the benefits of blue skies inside. BIOS SkyBlue is the only spectrally optimized circadian solution to target the region that drives wellness benefits including: increased alertness, enhanced productivity, better mood, and better sleep. More information may be found at [www.bioslighting.com](http://www.bioslighting.com) or by contacting Day-O-Lite directly. All options for 0-10V control.

**BIOS Biological Static**

For daytime applications. BIOS Static Biological LED features key BIOS SkyBlue (490nm) for maximum daytime circadian impact.

B30 = 3000K  
 B35 = 3500K  
 B40 = 4000K

**BIOS Biological Dynamic White**

Designed to transition from daytime to evening in a dim-to-warm protocol. The daytime CCT includes full BIOS SkyBlue (490nm) for maximum daytime circadian impact, while the evening spectrum removes BIOS SkyBlue for minimal circadian stimulus after hours.

B30D = 3000K-2700K  
 B35D = 3500K-3000K  
 B40D = 4000K-3500K

**BIOS Biological Tunable White**

Designed to transition from daytime to evening in a tunable white protocol. The daytime CCT includes full BIOS SkyBlue (490nm) for maximum daytime circadian impact, while the evening spectrum removes BIOS SkyBlue for minimal circadian stimulus after hours.

B30T = 3000K-2700K  
 B35T = 3500K-2700K  
 B40T = 4000K-2700K

**Sensors & Controls****Sensors\***

AVO = Avi-On Occ/Day  
 AVM = Avi-On Occ (Microwave)  
 BNV = BubblyNet Occ/Day  
 ENC = Encelium Occ/Day  
 ENL = EnLighted Occ/Day/Temp  
 LEG = Legrand Occ/Day  
 ANW = Lutron Athena Occ/Day  
 VIVE = Lutron Vive Occ/Day  
 NLT = Acuity nLight Occ/Day  
 NXC = Current NX Occ/Day  
 ESN = Philips EasySense Occ/Day  
 WWL = Cooper WaveLinX Occ/Day

**Wireless Control**

CAS = Casambi

\*Sensors for remote mount only.

Sensors and control options to be commissioned wirelessly in the field by qualified controls personnel with applicable apps (by others).

**Other Options**

Other sensor and wireless control options are available. Contact factory for details.

<sup>1</sup>Tunable white may be controlled by a number of dimming protocols as shown.

<sup>2</sup>Dim-to-Warm mimics incandescent dimming by warming the CCT from 6500K to 2700K as light levels are dimmed.

<sup>3</sup>All RGB, RGBW and RGBWW options for DMX control (by others). 80 CRI standard.

### Mounting Options

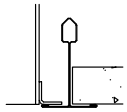

15/16" T-Bar  
(G)

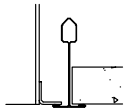

9/16" T-Bar  
(MG)

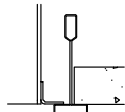

Slot Grid  
(SG)

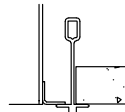

Interlude  
(XG)

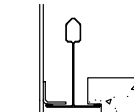

15/16" Tegular  
Flush  
(TGF)

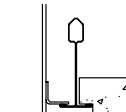

9/16" Tegular  
Flush  
(MTGF)

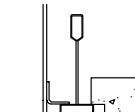

Slot Grid Flush  
(SGF)

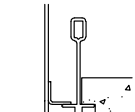

Interlude Flush  
(XGF)

### Housing and Lens Details

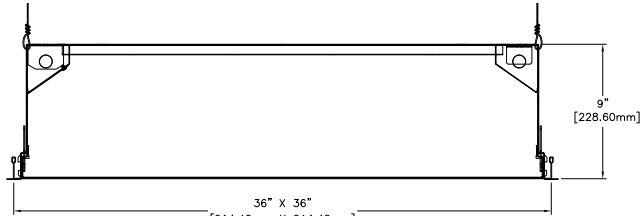

Grid Ceiling Flat Lens

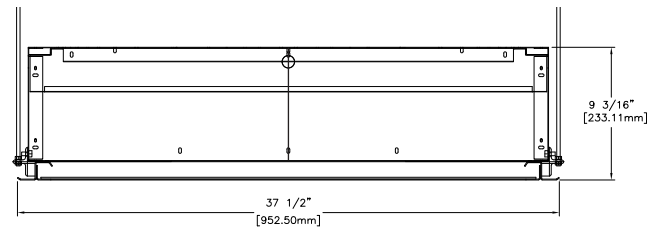

Drywall Ceiling Flat Lens

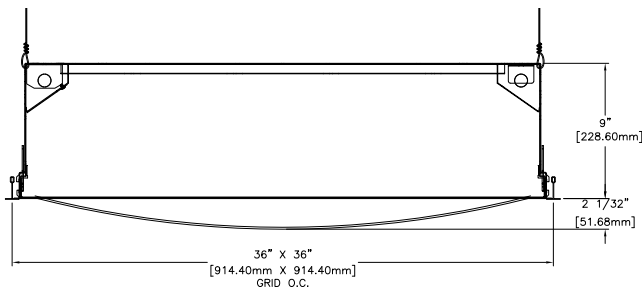

Grid Ceiling Convex Lens

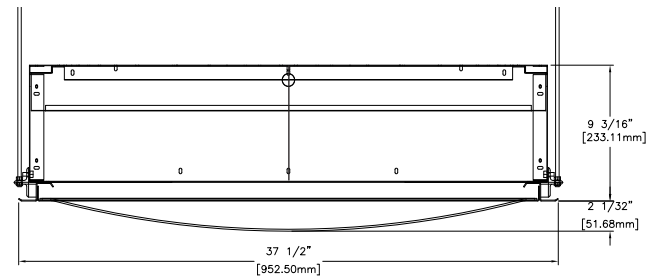

Drywall Ceiling Convex Lens

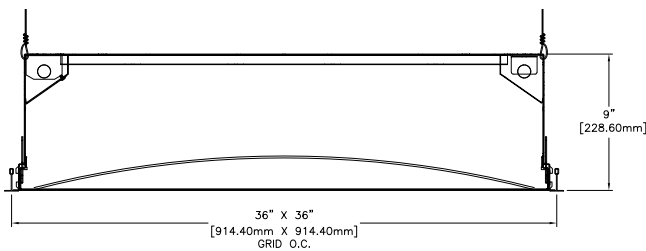

Grid Ceiling Concave Lens

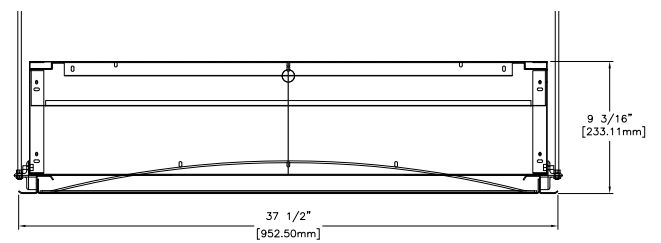

Drywall Ceiling Concave Lens

### Drywall/Plaster Ceiling

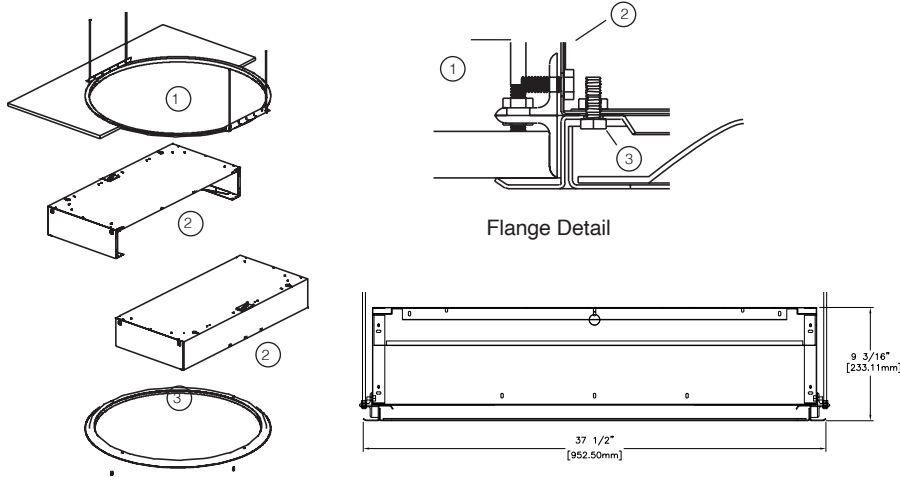

- ① Secure plaster frame to the ceiling with rods or wire ties. The plaster frames are ship prior to the fixture for ceiling preparation.
- ② Insert the fixture sections one at a time. The fixture housing is fabricated in two mating sections to allow entry through the plaster frame aperture, the housing is furnished with the necessary hardware for field attachment.
- ③ Install the lens frame assembly to the fixture housing. The lens frame is provided with hardware and is tethered to allow access inside the fixture. The lens door is secured with a bayonet twist locking action.

### Photometry

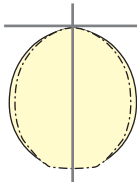

#### GRID

NASL-RND-D-SI-40- <b>LO</b> -3-G	NASL-RND-SI-40- <b>SO</b> -3-G	NASL-RND-SI-40- <b>HO</b> -3-G
4000K CCT WATTS: 40 LUMENS: 3975 LPW = 99	4000K CCT WATTS: 55 LUMENS: 5300 LPW = 98	4000K CCT WATTS: 70 LUMENS: 5300 LPW = 94

#### FLANGE

NASL-RND-D-SI-40- <b>LO</b> -3-F	NASL-RND-D-SI-40- <b>SO</b> -3-F	NASL-RND-D-SI-40- <b>SO</b> -3-F
4000K CCT WATTS: 61 LUMENS: 5625 LPW = 92	4000K CCT WATTS: 81 LUMENS: 5625 LPW = 92	4000K CCT WATTS: 101 LUMENS: 5625 LPW = 91

4000K @ 80CRI, SI lens. DLC @ 3500K & 400K.

Use the following multipliers for other CCTs: 2700K x 0.94, 3000K x 0.96, 3500K x 0.98, 5000K x 1.02. IES files @ [www.dayolite.com](http://www.dayolite.com)

### Tamper Resistant Option

GT = Grid Ceilings Tamper Resistant

FT = Flanged Tamper Resistant

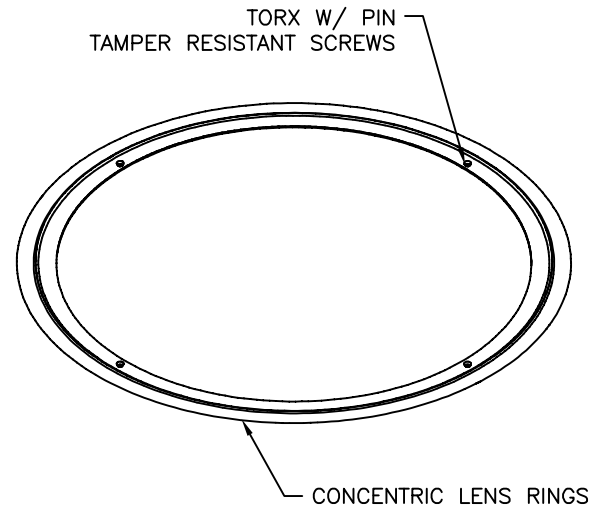
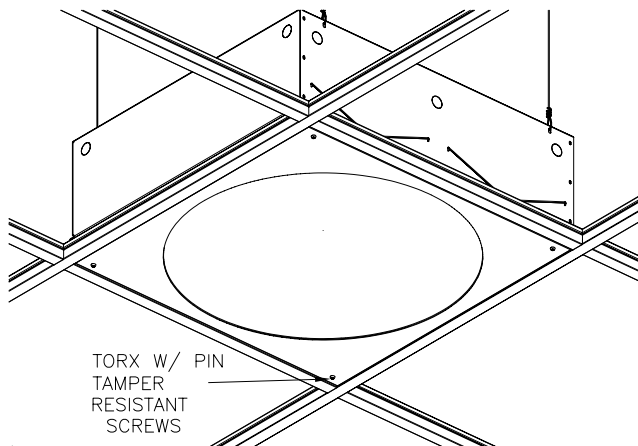

## Specifications

**CONSTRUCTION:** 20 gauge CRS housing and internal components.

**REFLECTOR:** 20 gauge CRS finished in highly reflective baked white enamel with pre-finished reflective LED tray.

**OPTICS:** LED optimized Satin Ice acrylic lay-in lens and convex acrylic lens. Polycarbonate tamper resistant lens available.

**LED:** Static white LED modules in 27/30/35/40 & 50K CCT, 80/90CRI. Lumen maintenance minimum  $L_{70}$  = 50,000 hours. 3 SDCM color consistency. BIOS SkyBlue, RGB, RGBW, RGBWW. Tunable White and Dim-to-Warm options available; field replaceable.

**DRIVER:** Driver is Class 2 AOC 0-10V to 1%, Dim-to-Off available. 120/277V input, PF > 90%, THD < 20 @ 120V. Additional dimming protocols available. All drivers prewired from factory for connection to control system (by others); field replaceable.

**MOUNTING:** Standard installation is in an exposed inverted T-bar ceiling. Fixtures are supplied with four support brackets for additional support to T-bar. May also be installed in plaster ceilings (F/TRL mounting option with Flange). Tamper resistant mounting option available.

**FINISH:** Housing and components finished in baked white enamel.

**CERTIFICATION:** cETLus listed, conforming to UL STD. 1598 and certified to CSA STD C22.2 NO. 250.0. Suitable for dry & damp locations. Union Made in the United States of America, I.B.E.W, BAA compliant, Declare Red List Approved.

**LEGAL:** Day-O-Lite, a division of SCW Corporation. All rights reserved. The Day-O-Lite logo is a registered trademark of SCW Corporation. Day-O-Lite reserves the right to change specifications without notice for product improvement.