

Date	Notes
Project	
Type	Qty

### Features

- Extruded aluminum housing w/welded end caps.
- LED optimized optics for smooth, efficient illumination.
- Individual fixtures, continuous rows or custom patterns.
- Programmable driver for custom lumen packages.
- 0-10V dimming to 1% standard. Dim-to-off available.
- DMX, Lutron and DALI protocols also available.
- Sensor Ready for wireless Smart Lighting Solutions.
- 80/90CRI, Tunable White, RGBW & RGBWW.
- Bios SkyBlue™ circadian solutions available.

**Declare** Red List Approved.

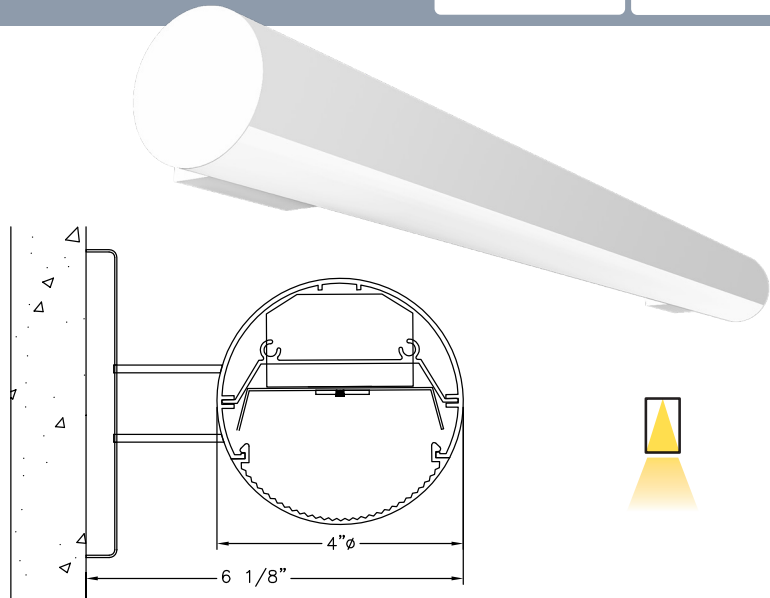

### Ordering Guide



MODEL	OPTICS	LED <sup>1</sup>	LUMENS <sup>2</sup>	LENGTH	MOUNTING <sup>3</sup>	FINISH	OPTIONS
<b>ADL-RO4-D</b>	<b>WRA</b>				<b>WM</b>		
ADL-RO4-D Direct	WRA = White Acrylic Ribbed Lens	<b>STATIC WHITE</b> 27 = 2700K 30 = 3000K 35 = 3500K 40 = 4000K 50 = 5000K  <b>BIOS SkyBlue</b> Spectrally optimized circadian solutions.  <b>TUNABLE WHITE</b> (2700K-6500K) 2DIM10 = for 0-10V 2DMX = for DMX 2ESN = for Philips 2CAS = for Casambi 2LUT = for Lutron  <b>DIM-TO-WARM</b> (2700K-6500K) DTW = Dim-to-Warm  <b>RGB + WHITE</b> RGB = RGB RGBW = RGBW RGBWW = RGBWW	LO = 600/ft (5W/ft, 120LPW)  SO = 800/ft (7W/ft, 118LPW)  HO = 1000/ft (9W/ft, 114LPW)  <b>CUSTOM</b> For custom lumens specify value < HO.	4 = 4 ft 6 = 6 ft 8 = 8 ft  For other enter row length (e.g. 48 = 48 ft)	WM = Wall Mount	W = White CC = Custom Color AMW = Anti-Microbial White	<b>DIMMING DRIVERS</b> DIM10 = 0-10V (1%) Standard DTO = 0-10V (Dim-to-Off) DIMST = 0-10V Step Dimming DIMSR = DALI Sensor Ready (5.0%) DALI = DALI (5.0%) DMX = DMX  <b>LUTRON™ DIMMING DRIVERS</b> LDE1 = Hi-Lume 1% EcoSystem LD2 = Digital 1% (DALI-2) L3DA3W = Hi-Lume 1% 3-Wire  <b>SENSORS &amp; CONTROLS<sup>4</sup></b> AVO = Avi-On Sensor AWNS = Lutron Athena Sensor ESN = EasySense Sensor CAS = Casambi Wireless Control  <b>EMERGENCY &amp; OTHER<sup>5</sup></b> EMC = Emergency Circuit GTD = Generator Transfer Device EPC4 = 4W Emergency Battery EPC6 = 6.5W Emergency Battery EPC10 = 10W Emergency Battery EPC12 = 12W Emergency Battery  <b>WIRING</b> FWH = Flexible Wiring Harness DWH = DMX Wiring Harness

<sup>1</sup>All LED, BIOS, Tunable White, DTW, and RGB/W options and Ordering Codes page 2.

<sup>2</sup>Lumens at 80CRI, 4000K, WRA lens. Photometry page 4.

<sup>3</sup>See page 4 for mounting option details.

<sup>4</sup>All Sensor & Control options page 2.

<sup>5</sup>EPC6 is standard unless otherwise specified. EPC not for DMX drivers.

**BAA** letter of compliance available at [www.dayolite.com](http://www.dayolite.com).

**LED, BIOS, Sensor & Control Ordering Codes****LED****Static White**

30 = 3000K 80 CRI  
 35 = 3500K 80 CRI  
 40 = 4000K 80 CRI  
 50 = 5000K 80 CRI

927 = 2700K 90 CRI  
 930 = 3000K 90 CRI  
 935 = 3500K 90 CRI  
 940 = 4000K 90 CRI

**Tunable White<sup>1</sup>**  
(2700K-6500K)

2DIM10 = 0-10V 80 CRI  
 2DMX = DMX 80 CRI  
 2CAS = Casambi Wireless 80 CRI  
 2ESN = Philips EasySense 80 CRI  
 2LUT = Lutron (LD2) 80 CRI

92DIM10 = 0-10V 90 CRI  
 92DMX = DMX 90 CRI  
 92CAS = Casambi Wireless 90 CRI  
 92ESN = Philips EasySense 90 CRI  
 92LUT = Lutron (LD2) 90 CRI

**Dim-to-Warm<sup>2</sup>**

DTW = 6500K-2700K 80 CRI  
 9DTW = 6500K-2700K 90 CRI

**RGB/W<sup>3</sup>**  
(DMX driver standard)

RGB = RGB only  
 RGB27 = RGB w/2700K  
 RGB30 = RGB w/3000K  
 RGB35 = RGB w/3500K  
 RGB40 = RGB w/4000K  
 RGB50 = RGB w/5000K  
 RGBWW = RGB w/2700K-6500K

**Single Color**

RED = Red  
 BLU = Blue  
 GRN = Green  
 AMB = Amber

**BIOS SkyBlue**

BIOS SkyBlue biological technology brings the benefits of blue skies inside. BIOS SkyBlue is the only spectrally optimized circadian solution to target the region that drives wellness benefits including increased alertness, enhanced productivity, better mood, and better sleep. More information may be found at [www.bioslighting.com](http://www.bioslighting.com) or by contacting Day-O-Lite directly. All options for 0-10V control.

**BIOS Biological Static**

For daytime applications. BIOS Static Biological LED features key BIOS SkyBlue (490nm) for maximum daytime circadian impact.

B30 = 3000K  
 B35 = 3500K  
 B40 = 4000K

**BIOS Biological Dynamic White**

Designed to transition from daytime to evening in a dim-to-warm protocol. The daytime CCT includes full BIOS SkyBlue (490nm) for maximum daytime circadian impact, while the evening spectrum removes BIOS SkyBlue for minimal circadian stimulus after hours.

B30D = 3000K-2700K  
 B35D = 3500K-3000K  
 B40D = 4000K-3500K

**BIOS Biological Tunable White**

Designed to transition from daytime to evening in a tunable white protocol. The daytime CCT includes full BIOS SkyBlue (490nm) for maximum daytime circadian impact, while the evening spectrum removes BIOS SkyBlue for minimal circadian stimulus after hours.

B30T = 3000K-2700K  
 B35T = 3500K-2700K  
 B40T = 4000K-2700K

**Sensors & Controls****Sensors\***

AVO = Avi-On Occ/Day  
 AVM = Avi-On Occ (Microwave)  
 BNV = BubblyNet Occ/Day  
 ENC = Encelium Occ/Day  
 ENL = EnLighted Occ/Day/Temp  
 LEG = Legrand Occ/Day  
 ANW = Lutron Athena Occ/Day  
 VIVE = Lutron Vive Occ/Day  
 NLT = Acuity nLight Occ/Day  
 NXC = Current NX Occ/Day  
 ESN = Philips EasySense Occ/Day  
 WWL = Cooper WaveLinx Occ/Day

**Wireless Control**

CAS = Casambi

\*Sensors for remote mount only.

Sensors and control options to be commissioned wirelessly in the field by qualified controls personnel with applicable apps (by others).

**Other Options**

Other sensor and wireless control options are available. Contact factory for details.

<sup>1</sup>Tunable white may be controlled by a number of dimming protocols as shown.

<sup>2</sup>Dim-to-Warm mimics incandescent dimming by warming the CCT from 6500K to 2700K as light levels are dimmed.

<sup>3</sup>All RGB, RGBW and RGBWW options for DMX control (by others). 80 CRI standard.

### Individual Fixtures & Continuous Rows

NOMINAL LENGTH	ACTUAL LENGTH	WALL BRKTS.	WALL O.C. 1	WALL O.C. 2	WALL O.C. 3+
4'	4' 1/4"	2	38"		
8'	8' 1/4"	2	48"		
12'	12' 1/4"	3	48"	48"	
16'	16' 1/4"	4	48"	48"	48"
20'	20' 1/4"	5	48"	48"	48"
24'	24' 1/4"	6	48"	48"	48"

Individual fixtures and rows are continuously illuminated and joined with included aligner brackets and hardware. Lengths and mounting locations are shown below.

Individual fixtures up to 8' nominal and continuous rows up to 24' nominal are dimensioned as shown below. Continuous rows longer than 8' and patterns, including EPC/EMC and sensor locations must be approved prior to manufacturing.

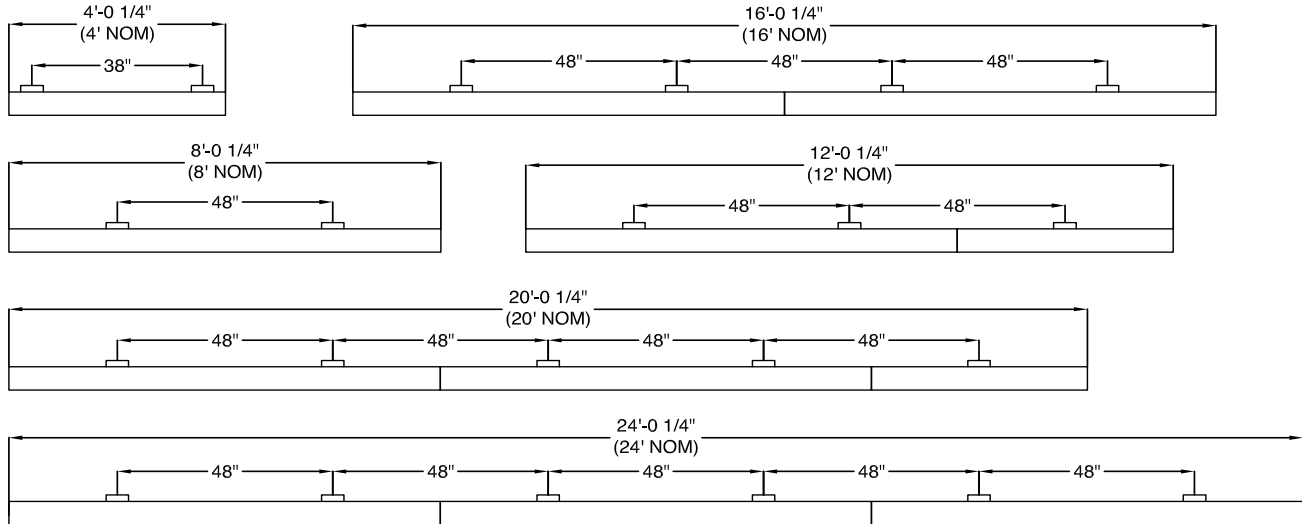

### Emergency & Sensor Locations

EPC will control entire length of individual fixtures. Individual fixtures of differing lengths will deliver the same lumens under EPC power (a 4' fixture will deliver the same total lumens over half the length of an 8' fixture). EMC controlled individual fixtures will deliver lumens per foot as originally specified, unless dimmed at time of power loss. Consult factory for EMC dimming override device.



For individual fixtures to 8' EPC/EMC will power entire fixture.

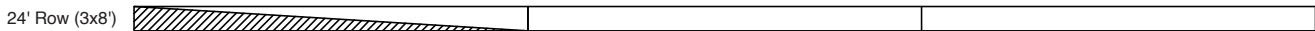

For continuous rows longer than 8' one EPC/EMC will be located in the feed section (end-left) of the row as shown below.

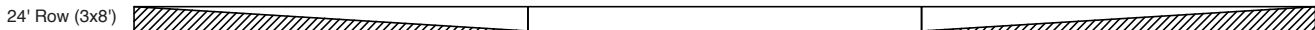

If two EPC/EMC's are required their default locations will be in the feed section (end-left) and last section (end-right) as below.



Custom placement of one or more EPC/EMC's must be clearly identified during ordering.



SENSORS (Integral) for individual fixtures will control entire length of fixture and will be located on feed end of fixture.

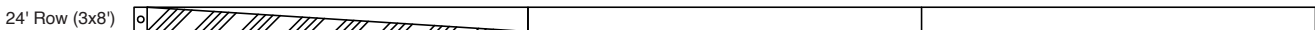

SENSORS for rows by default will control the feed section (end-left) of the row. Sensors can control more than an 8' section within a row. Consult factory for sensor/section options, or for multiple sensors in a continuous row.

### Photometry

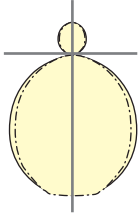

**ADL-RO4-D-WRA-40-LO-4**  
 4000K CCT  
 WATTS: 20  
 LUMENS: 2400  
 LPW: 120  
 Distribution:  
 92% Direct,  
 8% Indirect

**ADL-RO4-D-WRA-40-SO-4**  
 4000K CCT  
 WATTS: 27  
 LUMENS: 3205  
 LPW: 118  
 Distribution:  
 92% Direct,  
 8% Indirect

**ADL-RO4-D-WRA-40-HO-4**  
 4000K CCT  
 WATTS: 35  
 LUMENS: 4006  
 LPW: 114  
 Distribution:  
 92% Direct,  
 8% Indirect

4000K @ 80CRI, 4', WRA lens.

Use the following multipliers for other CCTs: 2700K x 0.94, 3000K x 0.96, 3500K x 0.98, 5000K x 1.02. IES files @ [www.dayolite.com](http://www.dayolite.com)

### Wall Bracket Detail

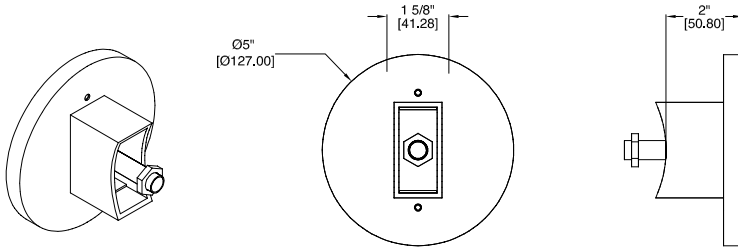

### Specifications

**HOUSING:** Extruded aluminum housing. Joiner ends are notched for continuous appearance in row-mounted applications. Machined end-caps.

**REFLECTOR:** Die-formed steel finished in highly reflective baked white enamel.

**OPTICS:** LED optimized white ribbed acrylic lens (WRA) is standard.

**LED** Static white LED modules in 27/30/35/40 & 50K CCT, 80/90CRI. Lumen maintenance minimum  $L_{70}$ = 50,000 hours. 3 SDCM color consistency. BIOS SkyBlue, RGB, RGBW and Tunable White and Advanced Color options available.

**DRIVER:** Standard driver is Class 2 AOC 0-10V to 1%, 120/277V input, PF > 90%, THD < 20 @ 120V. Additional dimming protocols available. All drivers prewired from factory for connection to control system (by others). Field replaceable.

**MOUNTING:** Standard installation is wall mount with included mounting brackets and hardware. Requires single-gang j-box supplied by others.

**FINISH:** Aluminum fixture housing and steel components are finished in baked white enamel applied over a five-stage pretreatment process.

**CERTIFICATION:** cETLus listed conforming to UL STD. 1598 and certified to CSA STD C22.2 NO. 250.0. Suitable for dry & damp locations. Union Made in the United States of America, I.B.E.W, BAA compliant, Declare Red List Approved.

**LEGAL:** Day-O-Lite, a division of SCW Corporation. All rights reserved. The Day-O-Lite logo is a registered trademark of SCW Corporation. Day-O-Lite reserves the right to change specifications without notice for product improvement.