



# New Age Series | NASL-2821 1X4

Date	Notes
Project	
Type	Qty

## Features

- The open concave reflector is indirectly illuminated by LEDs creating a very smooth, glare free look.
- LED optimized optics for smooth, efficient illumination.
- Programmable driver for custom lumen packages.
- 0-10V dimming to 1% standard or Dim-to-Off.
- DMX, Lutron and DALI protocols also available.
- Sensor Ready for wireless Smart Lighting Solutions.
- 80/90CRI, Tunable White, RGBW & RGBWW.
- Bios SkyBlue™ circadian solutions available.
- Compatible with Armstrong® ceiling systems.

**Declare** Red List Approved.

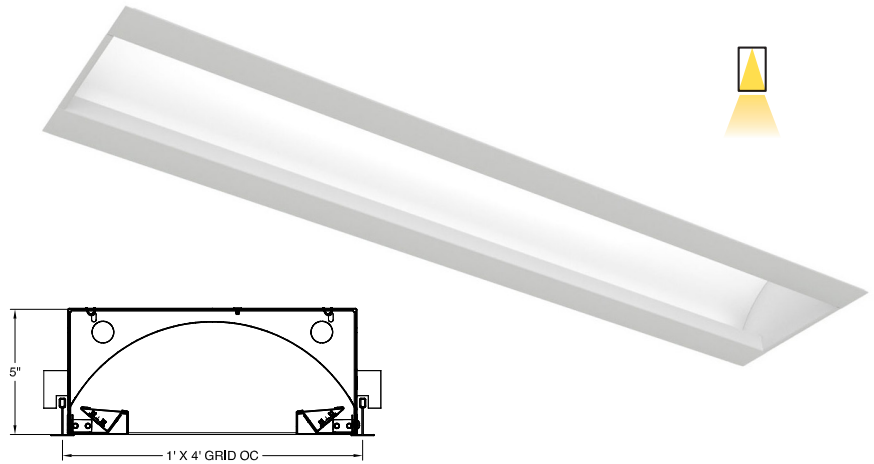

## Ordering Guide



MODEL	OPTICS	CCT <sup>1</sup>	LUMENS <sup>2</sup>	SIZE	MOUNTING <sup>3</sup>	FINISH	OPTIONS
<b>NASL-2821-D</b>	<b>DC</b>			<b>22</b>			
NASL-2821-D Direct	DC = LED Optimized diffuse dust covers in an open reflector housing.	<b>STATIC WHITE</b> 27 = 2700K 30 = 3000K 35 = 3500K 40 = 4000K 50 = 5000K  <b>BIOS SkyBlue</b> Spectrally optimized circadian solutions.  <b>TUNABLE WHITE</b> (2700K-6500K) 2DIM10 = for 0-10V 2DMX = for DMX 2ESN = for Phillips 2CAS = for Casambi 2LUT = for Lutron  <b>DIM-TO-WARM</b> DTW = Dim-to-Warm  <b>RGB &amp; WHITE</b> RGB = RGB RGBW = RGBW RGBWW = RGBWW (2700K-6500K)	LO = 3530L (40W, 84LPW)  SO = 4473L (54W, 82LPW)  HO = 5585L (70W, 79LPW)  <b>CUSTOM</b> Specify value < HO.	22 = 2x2	G = Grid 15/16" T-Bar  MG = Mini Grid 9/16" T-Bar  SG = Slot Grid  SGF = Slot Grid Flush  XG = Interlude  XGF = Interlude Flush  TGF = Tegular Flush 15/16" T-Bar  XGF = Tegular Flush 9/16" T-Bar  S = Surface  F = Flange	W = White  CC = Custom Color  AMW = Anti-Microbial White	<b>DIMMING DRIVERS</b> DIM10 = 0-10V (1%) Standard DTO = 0-10V (Dim-to-Off) DIMST = 0-10V Step Dimming DIMSR = DALI Sensor Ready (5.0%) DALI = DALI (5.0%) DMX = DMX  <b>LUTRON™ DIMMING DRIVERS</b> LDE1 = Hi-Lume 1% EcoSystem LD2 = Digital 1% (DALI-2) L3DA3W = Hi-Lume 1% 3-Wire  <b>SENSORS &amp; CONTROLS<sup>4</sup></b> AVO = Avi-On Sensor AWNS = Lutron Athena Sensor ESN = EasySense Sensor CAS = Casambi Wireless Control  <b>EMERGENCY &amp; OTHER<sup>5</sup></b> EMC = Emergency Circuit GTD = Generator Transfer Device EPC4 = 4W Emergency Battery Pack EPC6 = 6.5W Emergency Battery Pack EPC10 = 10W Emergency Battery Pack EPC12 = 12W Emergency Battery Pack  <b>WIRING &amp; OTHER</b> FWH = Flexible Wiring Harness FK14 = Flange Kit

<sup>1</sup>All LED, BIOS, Tunable White, DTW, and RGB/W options and Ordering Codes page 2.

<sup>2</sup>Lumens at 80CRI, 3500K, SI lens. Photometry page 3.

<sup>3</sup>See page 3 for all mounting options.

<sup>4</sup>All Sensor & Control options page 2. Sensors remote mount only.

<sup>5</sup>EPC6 is standard unless otherwise specified. EPC not for DMX drivers.

**BAA** letter of compliance available at [www.dayolite.com](http://www.dayolite.com).

**LED, BIOS, Sensor & Control Ordering Codes****LED****Static White**

30 = 3000K 80 CRI  
 35 = 3500K 80 CRI  
 40 = 4000K 80 CRI  
 50 = 5000K 80 CRI

927 = 2700K 90 CRI  
 930 = 3000K 90 CRI  
 935 = 3500K 90 CRI  
 940 = 4000K 90 CRI

**Tunable White<sup>1</sup>**  
(2700K-6500K)

2DIM10 = 0-10V 80 CRI  
 2DMX = DMX 80 CRI  
 2CAS = Casambi Wireless 80 CRI  
 2ESN = Philips EasySense 80 CRI  
 2LUT = Lutron (LD2) 80 CRI

92DIM10 = 0-10V 90 CRI  
 92DMX = DMX 90 CRI  
 92CAS = Casambi Wireless 90 CRI  
 92ESN = Philips EasySense 90 CRI  
 92LUT = Lutron (LD2) 90 CRI

**Dim-to-Warm<sup>2</sup>**

DTW = 6500K-2700K 80 CRI  
 9DTW = 6500K-2700K 90 CRI

**RGB/W<sup>3</sup>**

RGB = RGB only  
 RGB27 = RGB w/2700K  
 RGB30 = RGB w/3000K  
 RGB35 = RGB W/3500K  
 RGB40 = RGB w/4000K  
 RGB50 = RGB w/5000K  
 RGBWW = RGB w/2700K-6500K

**Single Color**

RED = Red  
 BLU = Blue  
 GRN = Green  
 AMB = Amber

**BIOS SkyBlue**

BIOS SkyBlue biological technology brings the benefits of blue skies inside. BIOS SkyBlue is the only spectrally optimized circadian solution to target the region that drives wellness benefits including: increased alertness, enhanced productivity, better mood, and better sleep. More information may be found at [www.bioslighting.com](http://www.bioslighting.com) or by contacting Day-O-Lite directly. All options for 0-10V control.

**BIOS Biological Static**

For daytime applications. BIOS Static Biological LED features key BIOS SkyBlue (490nm) for maximum daytime circadian impact.

B30 = 3000K  
 B35 = 3500K  
 B40 = 4000K

**BIOS Biological Dynamic White**

Designed to transition from daytime to evening in a dim-to-warm protocol. The daytime CCT includes full BIOS SkyBlue (490nm) for maximum daytime circadian impact, while the evening spectrum removes BIOS SkyBlue for minimal circadian stimulus after hours.

B30D = 3000K-2700K  
 B35D = 3500K-3000K  
 B40D = 4000K-3500K

**BIOS Biological Tunable White**

Designed to transition from daytime to evening in a tunable white protocol. The daytime CCT includes full BIOS SkyBlue (490nm) for maximum daytime circadian impact, while the evening spectrum removes BIOS SkyBlue for minimal circadian stimulus after hours.

B30T = 3000K-2700K  
 B35T = 3500K-2700K  
 B40T = 4000K-2700K

**Sensors & Controls****Sensors\***

AVO = Avi-On Occ/Day  
 AVM = Avi-On Occ (Microwave)  
 BNV = BubblyNet Occ/Day  
 ENC = Encelium Occ/Day  
 ENL = EnLighted Occ/Day/Temp  
 LEG = Legrand Occ/Day  
 ANW = Lutron Athena Occ/Day  
 VIVE = Lutron Vive Occ/Day  
 NLT = Acuity nLight Occ/Day  
 NXC = Current NX Occ/Day  
 ESN = Philips EasySense Occ/Day  
 WWL = Cooper WaveLinX Occ/Day

**Wireless Control\***

CAS = Casambi

\*Sensors for remote mount only.

Sensors and control options to be commissioned wirelessly in the field by qualified controls personnel with applicable apps (by others).

**Other Options**

Other sensor and wireless control options are available. Contact factory for details.

<sup>1</sup>Tunable white may be controlled by a number of dimming protocols as shown.

<sup>2</sup>Dim-to-Warm mimics incandescent dimming by warming the CCT from 6500K to 2700K as light levels are dimmed.

<sup>3</sup>All RGB, RGBW and RGBWW options for DMX control (by others). 80 CRI standard.

## Mounting Options

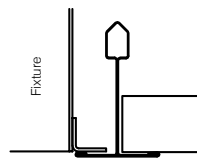

**G**  
15/16" T-Bar

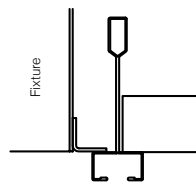

**SG**  
Slot Grid

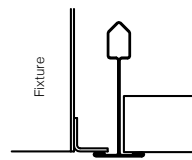

**MG**  
9/16" T-Bar

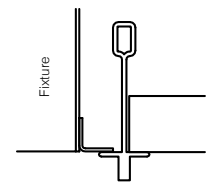

**XG**  
Interlude

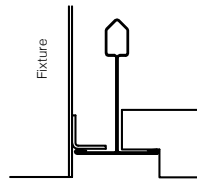

**TGF**  
15/16" Tegular  
Flush

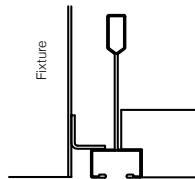

**SGF**  
Slot Grid  
Flush

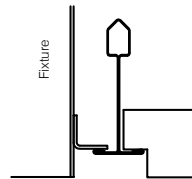

**MTGF**  
9/16" Tegular  
Flush

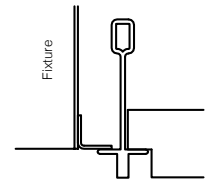

**XGF**  
Interlude  
Flush

## Photometry

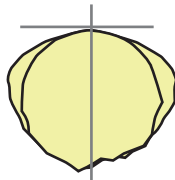

NASL-282-D-DC-35-**LO**-14  
CCT: 3500K  
WATTS: 40  
LUMENS: 3350  
LPW: 84

NASL-2821-D-DC-35-**SO**-14  
CCT: 3500K  
WATTS: 54  
LUMENS: 4473  
LPW: 82

HML-A-D-DC-35-**HO**-14  
CCT: 3500K  
WATTS: 70  
LUMENS: 5585  
LPW: 79

3500K @ 80CRI, 4'.

Use the following multipliers for other CCTs: 2700K x 0.96, 3000K x 0.98, 4000K x 1.02, 5000K x 1.03. IES files @ [www.dayolite.com](http://www.dayolite.com)

## Specifications

**CONSTRUCTION:** 20 gauge CRS housing and internal components.

**REFLECTOR:** 20 gauge CRS finished in highly reflective baked white enamel with pre-finished reflective LED tray.

**OPTICS:** LED Optimized diffuse dust (DC) covers in an open reflector housing.

**LED:** Static white LED modules in 27/30/35/40 & 50K CCT, 80/90CRI. Lumen maintenance minimum  $L_{70}$  = 50,000 hours. 3 SDCM color consistency. BIOS SkyBlue, RGB, RGBW, RGBWW. Tunable White and Dim-to-Warm options available.

**DRIVER:** Driver is Class 2 AOC 0-10V to 1%, Dim-to-Off available. 120/277V input, PF > 90%, THD < 20 @ 120V. Additional dimming protocols available. All drivers prewired from factory for connection to control system (by others). Field replaceable.

**MOUNTING:** Standard installation is in an exposed inverted T-bar ceiling. Fixtures are supplied with four support brackets for additional support to T-bar. May also be installed in a plaster ceilings with flange kit or surface mounted.

**FINISH:** Housing and components finished in baked white enamel.

**CERTIFICATION:** cETLus listed conforming to UL STD. 1598 and certified to CSA STD C22.2 NO. 250.0. Suitable for dry & damp locations. Union Made in the United States of America, I.B.E.W, BAA compliant, Declare Red List Approved.

**LEGAL:** Day-O-Lite, a division of SCW Corporation. All rights reserved. The Day-O-Lite logo is a registered trademark of SCW Corporation. Day-O-Lite reserves the right to change specifications without notice for product improvement.

