



# Profile Series | PRFL-24-D Acoustic

|         |       |
|---------|-------|
| Date    | Notes |
| Project |       |
| Type    | Qty   |



20 unique colors & 4 wood grain finishes.

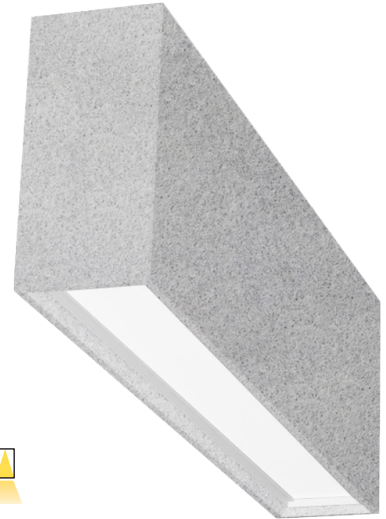

## Features

- Combines noise control and illumination in a simple lighting and acoustic solution.
  - Boosts human performance by reducing distracting noise levels and reverberations.
  - Promotes an inviting space for personal wellbeing, focus and concentration.
  - Improves privacy during sensitive communication by reducing echoes and reflected sound.
  - Creates a decorative floating ceiling in otherwise open-ceiling interior applications.
- A **Declare** Red List Approved product.



## Ordering Guide



| MODEL                           | OPTICS  | LED <sup>1</sup>  | LUMENS <sup>2</sup>   | LENGTH  | MOUNTING <sup>3</sup>                              | FINISH  | OPTIONS   |
|---------------------------------|---|---|---|---|--|---|---|
| <b>PRFL-24-D</b>                |   |   |   |   |  |   |   |
| PRFL-24-D<br>Direct<br>Acoustic | <b>STANDARD</b><br>FL = Flush Opal<br>Acrylic (snap-in)<br><br><b>OPTIONAL</b><br>DL = 1" Drop Opal<br>Acrylic (snap-in)<br><br>SCB = Cross Baffle<br>w/acrylic overlay<br><br><b>LIGHT SHAPING</b><br>(semi-diffuse)<br><br>AS =<br>Asymmetric<br>(lay-in)<br><br>CM =<br>Collimating<br>(lay-in)<br><br>BW =<br>Batwing<br>(lay-in)<br><br><b>BLACK OUT LENS</b><br>BK = Black Out<br>Lens<br>(20LPW maximum) | <b>STATIC WHITE</b><br>27 = 2700K<br>30 = 3000K<br>35 = 3500K<br>40 = 4000K<br>50 = 5000K<br><br><b>BIOS SkyBlue</b><br>Spectrally optimized<br>circadian solutions.<br><br><b>TUNABLE WHITE</b><br>(2700K-6500K)<br>2DIM10 = for 0-10V<br>2DMX = for DMX<br>2ESN = for Philips<br>2CAS = for Casambi-<br>2LUT = for Lutron<br><br><b>DIM-TO-WARM</b><br>(2700K-6500K)<br>DTW = Dim-to-Warm<br><br><b>RGB + WHITE</b><br>RGB = RGB<br>RGBW = RGBW<br>RGBWW = RGBWW<br><br><b>ADVANCED COLOR</b><br>125mm incremental<br>pixel color control for<br>chase and animated<br>effects. | LO = 502/ft<br>(5W/ft, 100LPW)<br><br>SO = 669/ft<br>(7W/ft, 100LPW)<br><br>HO = 835/ft<br>(8W/ft, 100LPW)<br><br>All outputs are for<br>12" high acoustic<br>solution.<br><br><b>CUSTOM</b><br>For custom<br>lumens specify<br>value < HO. | 2 = 2 ft<br>3 = 3 ft<br>4 = 4 ft<br>5 = 5 ft<br>6 = 6 ft<br>7 = 7 ft<br>8 = 8 ft<br><br>For other<br>enter row<br>length (e.g.<br>12 = 12 ft) | AC = Aircraft<br>Cable<br><br>PD = Pendant<br>Stem | <b>FIXTURE HOUSING</b><br><br>W = White<br><br>CC = Custom<br>Color<br><br><b>ACOUSTIC SOLUTIONS</b><br><br>See page 3<br>for Acoustic<br>color options,<br>ordering codes<br>and technical<br>information. | <b>DIMMING DRIVERS</b><br>DIM10 = 0-10V (1%) Standard<br>DTO = 0-10V (Dim-to-Off)<br>DIMST = 0-10V Step Dimming<br>DIMSR = DALI Sensor Ready (5.0%)<br>DALI = DALI (5.0%)<br>DMX = DMX<br><br><b>LUTRON™ DIMMING DRIVERS</b><br>LDE1 = Hi-Lume 1% EcoSystem<br>LD2 = Digital 1% (DALI-2)<br>L3DA3W = Hi-Lume 1% 3-Wire<br><br><b>SENSORS &amp; CONTROLS<sup>4</sup></b><br>AVO = Avi-On Sensor<br>AWNS = Lutron Athena Sensor<br>ESN = EasySense Sensor<br>CAS = Casambi Wireless Control<br><br><b>EMERGENCY<sup>5</sup></b><br>EMC = Emergency Circuit<br>GTD = Generator Transfer Device<br>EPC4 = 4W Emergency Battery<br>EPC6 = 6.5W Emergency Battery<br>EPC10 = 10W Emergency Battery<br>EPC12 = 12W Emergency Battery<br><br><b>WIRING</b><br>FWH = Flexible Wiring Harness<br>DWH = DMX Wiring Harness |

<sup>1</sup>All LED, BIOS, Tunable White, DTW, and RGB/W options and Ordering Codes page 2.

<sup>2</sup>Lumens at 80CRI, 3500K, FL lens. Photometry page 5.

<sup>3</sup>See page 5 for mounting option details.

<sup>4</sup>All Sensor & Control options page 2.

<sup>5</sup>EPC6 is standard unless otherwise specified. EPC not for DMX drivers.

**BAA** letter of compliance available at [www.dayolite.com](http://www.dayolite.com).

## LED, BIOS, Sensor &amp; Control Ordering Codes

## LED

**Static White**

30 = 3000K 80 CRI  
 35 = 3500K 80 CRI  
 40 = 4000K 80 CRI  
 50 = 5000K 80 CRI

927 = 2700K 90 CRI  
 930 = 3000K 90 CRI  
 935 = 3500K 90 CRI  
 940 = 4000K 90 CRI

**Tunable White<sup>1</sup>**  
(2700K-6500K)

2DIM10 = 0-10V 80 CRI  
 2DMX = DMX 80 CRI  
 2CAS = Casambi Wireless 80 CRI  
 2ESN = Philips EasySense 80 CRI  
 2LUT = Lutron (LD2) 80 CRI

92DIM10 = 0-10V 90 CRI  
 92DMX = DMX 90 CRI  
 92CAS = Casambi Wireless 90 CRI  
 92ESN = Philips EasySense 90 CRI  
 92LUT = Lutron (LD2) 90 CRI

**Dim-to-Warm<sup>2</sup>**

DTW = 6500K-2700K 80 CRI  
 9DTW = 6500K-2700K 90 CRI

**RGB/W<sup>3</sup>**

RGB = RGB only  
 RGB27 = RGB w/2700K  
 RGB30 = RGB w/3000K  
 RGB35 = RGB W/3500K  
 RGB40 = RGB w/4000K  
 RGB50 = RGB w/5000K  
 RGBWW = RGB w/2700K-6500K

**Single Color<sup>4</sup>**

RED = Red  
 BLU = Blue  
 GRN = Green  
 AMB = Amber

**Advanced Color<sup>5</sup>**

Advanced Color options combine RGB or RGBW with multi-pixel control for advanced chases, animated visual effects and other programmable scenes with 125mm pixel granularity.

ACRGB = RGB only  
 AC27 = RGB w/2700K  
 AC30 = RGB w/3000K  
 AC40 = RGB w/4000K

## BIOS SkyBlue

BIOS SkyBlue biological technology brings the benefits of blue skies inside. BIOS SkyBlue is the only spectrally optimized circadian solution to target the region that drives wellness benefits including: increased alertness, enhanced productivity, better mood, and better sleep. More information may be found at [www.bioslighting.com](http://www.bioslighting.com) or by contacting Day-O-Lite directly. All options for 0-10V control.

**BIOS Biological Static**

For daytime applications. BIOS Static Biological LED features key BIOS SkyBlue (490nm) for maximum daytime circadian impact.

B30 = 3000K  
 B35 = 3500K  
 B40 = 4000K

**BIOS Biological Dynamic White**

Designed to transition from daytime to evening in a dim-to-warm protocol. The daytime CCT includes full BIOS SkyBlue (490nm) for maximum daytime circadian impact, while the evening spectrum removes BIOS SkyBlue for minimal circadian stimulus after hours.

B30D = 3000K-2700K  
 B35D = 3500K-3000K  
 B40D = 4000K-3500K

**BIOS Biological Tunable White**

Designed to transition from daytime to evening in a tunable white protocol. The daytime CCT includes full BIOS SkyBlue (490nm) for maximum daytime circadian impact, while the evening spectrum removes BIOS SkyBlue for minimal circadian stimulus after hours.

B30T = 3000K-2700K  
 B35T = 3500K-2700K  
 B40T = 4000K-2700K

<sup>1</sup>Tunable white may be controlled by a number of dimming protocols as shown.

<sup>2</sup>Dim-to-Warm mimics incandescent dimming by warming the CCT from 6500K to 2700K as light levels are dimmed.

<sup>3</sup>All RGB, RGBW and RGBWW options for DMX control (by others). 80 CRI standard.

<sup>4</sup>Single colors are constant voltage LEDs. Dimming requires ELV controller (by others).

<sup>5</sup>White limited to 100L/ft.

## Sensors &amp; Controls

**Sensors\***

AVO = Avi-On Occ/Day  
 AVM = Avi-On Occ (Microwave)  
 BNV = BubblyNet Occ/Day  
 ENC = Encelium Occ/Day  
 ENL = EnLighted Occ/Day/Temp  
 LEG = Legrand Occ/Day  
 ANW = Lutron Athena Occ/Day  
 VIVE = Lutron Vive Occ/Day  
 NLT = Acuity nLight Occ/Day  
 NXC = Current NX Occ/Day  
 ESN = Philips EasySense Occ/Day  
 WWL = Cooper WaveLinX Occ/Day

**Wireless Control\***

CAS = Casambi

\*Sensors and control options to be commissioned wirelessly in the field by qualified controls personnel with applicable apps (by others).

Day-O-Lite's acoustic options integrate energy efficient architectural lighting with advanced sound absorbing technology in a sustainable, eco-friendly solution. Functional, attractive and easy to install, Day-O-Lite's acoustic solutions are ideal for use in educational, office, commercial, theatre and lobby applications.



**HOW TO SPECIFY**

- 1) Select color code from color swatches above.
- 2) Select height of acoustic panel - 8", 12" or 16".
- 3) Combine color and height to make complete code. Example: SK-12 = Sky, 12" high, FO-8 = Fossil, 8" high.
- 4) Enter completed code in Options section of Ordering Guide on page 1 of this Specification Sheet.

**SPECIFICATIONS**

- 100% Recyclable Polyester Material
- 1.6 Noise Reduction Coefficient (NRC)
- Class A Fire Rating
- Moisture and Mold Resistant
- UV Fade Resistant
- Stain repellent available

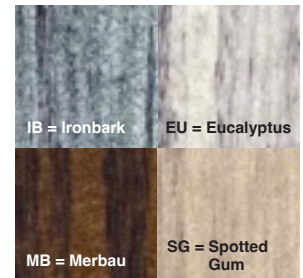

**NON-ILLUMINATED BAFFLES**

Non-Illuminated baffles matching the color and size of specified fixtures may also be ordered. These may be used as "fillers" between fixtures for added sound suppression, or alone as decorative elements. Specify as follows: PRFL-14-NIB (non-illuminated baffle)-XX (color)-YY (panel height). Example: PRFL-14-NIB-SL-16 = Profile 14 size, non-illuminated baffle, Slate color, 16" high panel. Day-O-Lite non-illuminated baffles are supplied with the same aircraft cable suspension as our acoustic luminaires and feature a closed bottom with a bevel detail to match fixtures and may be specified as individual units to 8', or as continuous rows.

**ADDITIONAL INFORMATION**

Smoke, Pewter and Slate are standard colors; consult factory for lead-times on other colors. Acoustic panels ship affixed to luminaires and are held in place by stop-blocks and double-sided tape to prevent bowing. On-site removal may result in damage and void warranty. Fixtures must be stored and installed in an interior dry location at a minimum of 52F.

**A NOTE ON SOUND ABSORPTION**

Per ASTM C423 there is no standard way to calculate sound absorption coefficients of non-standard shapes, sizes or spacing of material. Day-O-Lite's acoustic fixtures are tested using ASTM E795-16 Standard "Practices for Mounting Test Specimens During Sound Absorption Test", resulting in a noise reduction coefficient (NRC) unique to the test setup. When comparing sound suppressing materials those with a higher NRC will absorb more sound than those with a lower NRC, assuming the same test method is employed.

Additionally, more sound absorbing material in a space will result in greater sound suppression than less. Acoustic fixtures with 16" tall panels will be more effective at sound absorption than those with 8" or 12" high panels.

The full Acoustic Test Report, Certified Letter of Apparent NRC and Storage, Cleaning and Care information is available at [www.dayolite.com](http://www.dayolite.com).

**CUSTOM ACOUSTICS**

Acoustic Solutions may also be ordered in custom panel heights and with other custom modifications. Please contact Day-O-Lite directly to discuss your custom acoustic solutions today.

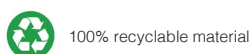
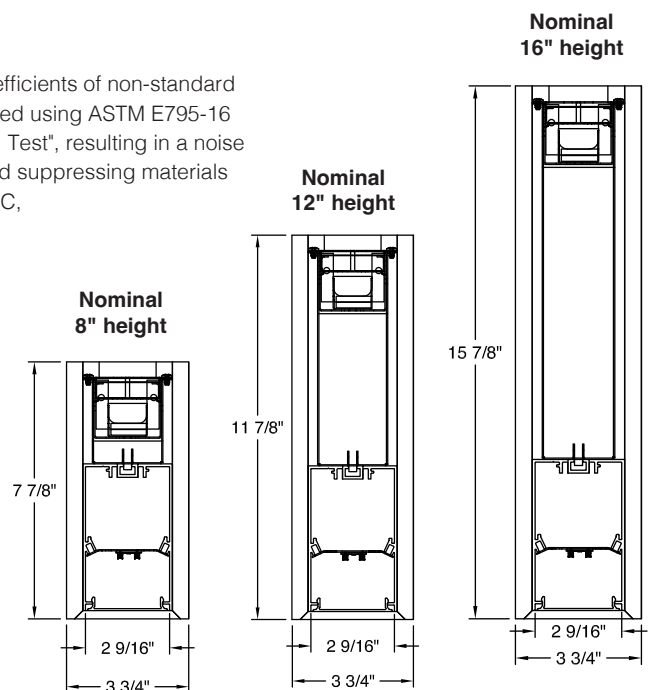

### Individual Fixtures & Continuous Rows

| NOMINAL LENGTH | ACTUAL LENGTH | SUSP. 1 O.C. | SUSP. 2 O.C. |
|----------------|---------------|--------------|--------------|
| 4'             | 48"           | 42 3/4"      |              |
| 8'             | 96"           | 90 3/4"      |              |
| 12'            | 11'-11"       | 90 3/4"      | 47"          |
| 16'            | 15'-11"       | 90 3/4"      | 95"          |

Individual fixtures and rows are continuously illuminated and joined with included aligner brackets and hardware. Mounting locations shown below.

Continuous rows longer than 8', including EPC/EMC and sensor locations must be approved prior to manufacturing.

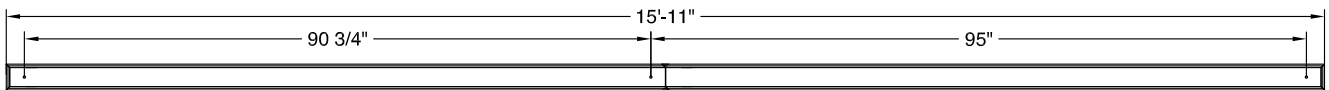
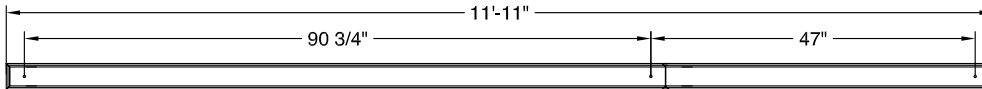
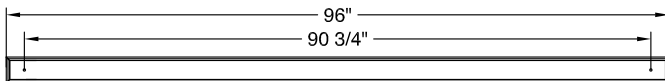
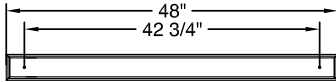

### Emergency & Sensor

**EPC** will control entire length of individual fixtures. Individual fixtures of differing lengths will deliver the same lumens under EPC power (a 4' fixture will deliver the same total lumens over half the length of an 8' fixture). **EMC** controlled individual fixtures will deliver lumens per foot as originally specified, unless dimmed at time of power loss. Consult factory for EMC dimming override device.

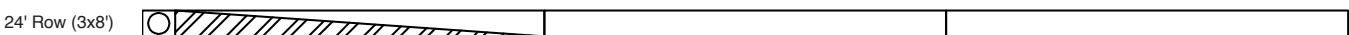
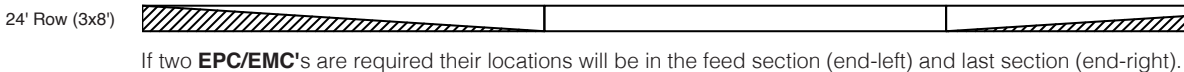
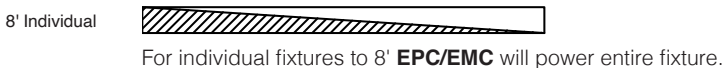

**SENSORS** for rows will control the feed section (end-left) of the row. Sensors can control more than an 8' section within a row. Consult factory for sensor/section options, or for multiple sensors in a continuous row.

## Standard Suspensions

Standard suspension options include adjustable self-locking aircraft cables (AC) and rigid pendant stems (PD). AC assembly is 48" x 1/16" with a 5" feed canopy and 2" suspension canopies. 60" 18 gauge power and 22 gauge dimming control SJT feed.

PD assemblies are 5/8" dia. (or 3/8" IP) hollow stem for power feed by others, 24" is standard. Consult factory for longer suspension lengths and other mounting options.

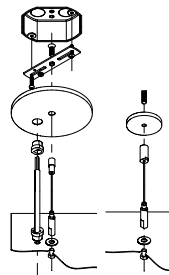

AC = Aircraft Cable

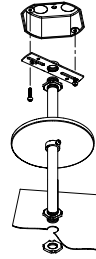

PD = Pendant Stem

## Photometry

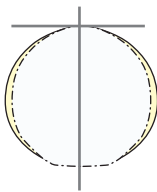

PRFL-24-D-FL-35-**LO**-4  
Flush Lens

3500K CCT  
WATTS: 20  
LUMENS: 2007  
LPW: 100

PRFL-24-D-FL-35-**SO**-4  
Flush Lens

3500K CCT  
WATTS: 27  
LUMENS: 2677  
LPW: 100

PRFL-24-D-FL-35-**HO**-4  
Flush Lens

3500K CCT  
WATTS: 33  
LUMENS: 3340  
LPW: 100

3500K @ 80CRI, 4', FL lens.

Use the following multipliers for other CCTs: 2700K x 0.96, 3000K x 0.98, 4000K x 1.02, 5000K x 1.03. IES files @ [www.dayolite.com](http://www.dayolite.com)

## Specifications

**ACOUSTIC PANELS:** 1/2" thick, 100% recyclable polyester material, Class A fire rating, moisture, mold and UV fade resistant.

**CONSTRUCTION:** Extruded aluminum housing. 20 gauge cold rolled steel internal components.

**REFLECTOR:** Highly reflective baked white enamel with pre-finished reflective LED tray.

**OPTICS:** Opal acrylic Flush lens is standard. 1" acrylic Drop lens, Steel Cross Baffle with acrylic overlay, Asymmetrical, Batwing, Collimating and Black Out lenses available.

**LED:** Static white LED modules in 30/35/40 & 50K CCT, 80/90CRI. Lumen maintenance minimum  $L_{70}$  = 50,000 hours. 3 SDCM color consistency. BIOS SkyBlue, RGB, RGBW, RGBWW, Advanced Color, Tunable White and Dim-to-Warm options available; field replaceable.

**DRIVER:** Standard driver is Class 2 AOC 0-10V to 1%, Dim-to-Off available. 120/277V input, PF > 90%, THD < 20 @ 120V. DMX, DALI & Lutron protocols available. All drivers prewired for connection to control system (by others); field replaceable.

**MOUNTING:** Standard options include adjustable self-locking aircraft cables (AC), and rigid pendant stems (PD). AC assembly is 48" x 1/16" with a 5" feed canopy and 2" suspension canopies. 18 gauge power and 22 gauge dimming control SJT feed. May also be surface ceiling mounted.

**FINISH:** Housing and components finished in baked white enamel. Canopies and pendant stems are white enamel unless otherwise specified. 5" Feed canopy w/2" Suspension canopies.

**CERTIFICATION:** cETLus listed conforming to UL STD. 1598 and certified to CSA STD C22.2 NO. 250.0. Suitable for dry & damp locations. Union Made in the United States of America. I.B.E.W., BAA compliant, Declare Red List Approved.

**LEGAL:** Day-O-Lite, a division of SCW Corporation. All rights reserved. The Day-O-Lite logo is a registered trademark of SCW Corporation. Day-O-Lite reserves the right to change specifications without notice for product improvement.