

Perimeter

PNR 9

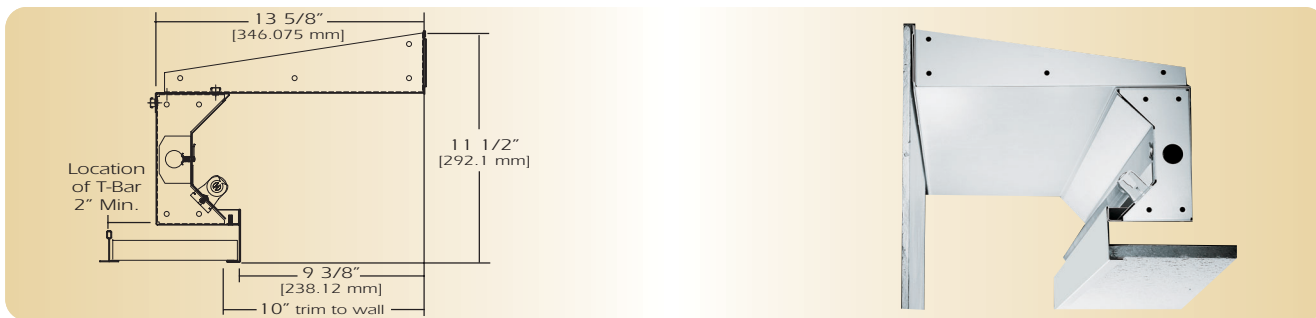

TYPE _____

FEATURES

The PNR 9 perimeter system is designed to produce diffused light with its concealed lamp source. Producing reflected horizontal illumination and disperses lamp imaging and socket shadows. Designed to produce no lamp image with increased illumination on walls to meet today's interior designs. The PNR 9 series is engineered to provide easy installation for this specific architectural cove requirement.

SPECIFICATIONS

Housing: Fully assembled one-piece die form 20-gauge cold rolled steel fixture is 11 1/2"x 13 5/8" and mounts to continuous wall rail system which provides exact horizontal mounting and ease of installation. All housings interlock with wall rail system and accepts tie wire (Supplied by others) for mounting and leveling. All housing are self flanged and join with alignment bracket and bolt together. Internally aligned by front and back alignment clips locking reflector system.

Reflector: Die formed 20-gauge cold rolled steel minimum 90% reflectivity finished in high gloss baked white enamel specular reflectors behind and on top of lamp.

Electrical: Ballast is electronic, high power factor, thermally protected class P, sound rated A, with less than 20% total harmonic distortion. The minimum number of ballast will be used unless otherwise specified.

Mounting: Recessed mounting for grid or flange ceilings.

Finish: Fixture housing and steel components are finished in baked white enamel applied over a five-stage pretreatment process.

Lamps: Fixtures are provided for use with one 32 watt T8 lamps, 28 watt T5 or 54 watt T5 HO lamps. (Supplied by Others)

Certification: Luminaires are U. L. Listed, C. S. A. certified and are Union Made in the United States of America I.B.E.W.

ORDERING GUIDE

MODEL NO.	LAMPS	MOUNTING	LENGTH	FINISH	VOLTAGE	OPTIONS
PNR 9	-	-	-	-	-	-
PNR 9	132T8 128T5 154T5 HO	G= Grid F= Flange	2 3 4 6 8	W= White CC= Custom Color	120v 277v	See Options Below
	O=Other Specify	See Accessories	for other, please enter row length (eg. 48=48ft)			

Example: **PNR 9-132T8-G-4-W-120V**
PNR 9 direct with one 32 watt T8 lamps grid ceiling application four foot fixture finished in baked white enamel 120v electronic ballast less than 20% total harmonic distortion.

OPTIONS

- E10=** Electronic ballast, high power factor, thermally protected class P, sound rated A, < 10% total harmonic distortion
- DIM=** Dimming Ballast
- EPC=** Emergency Battery Pack
- EMC=** Emergency Circuit
- OTH=** See Accessories for other options available

LINEAR SECTIONS AND SUSPENSION LOCATION

SUSPENSION MOUNTING

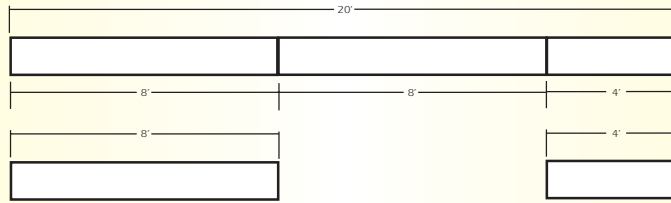

CORNERS

Corners and fixture extensions are custom fabricated to precise dimensions. Please indicate the specific requirements on the layout

IC = Inside Corner
OC = Outside Corner

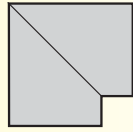

C2
90° Corner

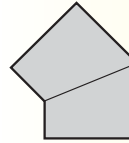

()° AC
Angular Corner

For any angular corner, ()° must be specified and dimensions must be included on the layout
For any pattern, a layout must accompany the order.

INSTALLATION PREPARATION

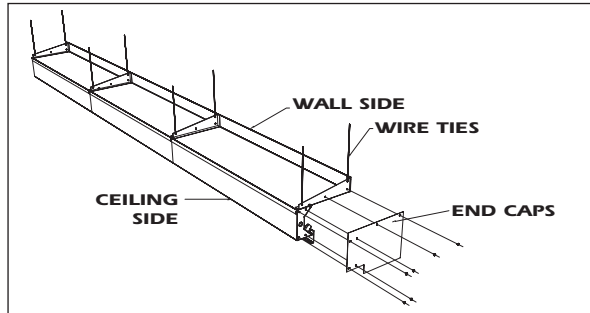
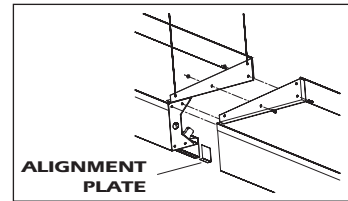
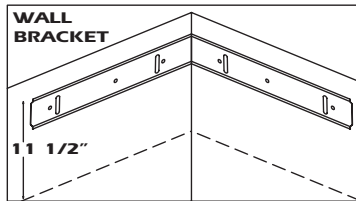

PHOTOMETRY

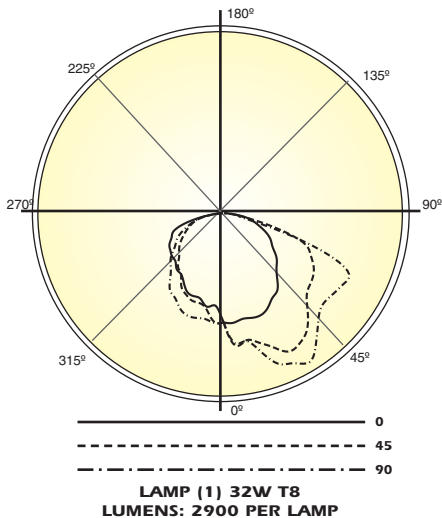

Candela Distribution:

Vert. Angle	0	45	90	135	180
0	440	440	440	440	440
5	443	535	526	568	444
10	433	520	523	526	416
15	436	539	577	547	435
20	437	573	646	589	431
25	420	615	667	596	412
30	393	608	692	611	418
35	378	582	647	556	375
40	334	527	590	516	329
45	301	473	550	471	300
50	278	452	542	452	266
55	242	440	551	431	241
60	219	417	562	417	217
65	191	385	551	381	187
70	154	337	375	332	163
75	123	194	110	192	122
80	84.1	67.7	61.9	62.6	84.2
85	29.4	20.2	27.0	17.5	28.8
90	3.45	1.57	3.20	2.40	2.94

Optical Distribution:
Direct

Coefficients of Utilization - Zonal Cavity Method:

pfc = 0.20

	.8	.7	.5	.3	.1	0										
pcc	.8	.7	.5	.3	.1	0										
pw	.7	.5	.3	.1	.5	.3	.1	.5	.3	.1	0					
RCR																
0	69	69	69	69	68	68	68	65	65	62	62	62	59	59	59	58
1	63	60	57	55	61	58	56	54	56	54	52	50	51	50	49	48
2	56	51	47	43	55	50	46	43	48	45	42	46	44	42	40	39
3	51	44	39	35	50	43	39	35	42	38	34	40	37	34	33	32
4	46	39	33	29	45	38	33	29	37	32	29	35	31	28	26	26
5	42	34	29	25	41	34	28	25	32	28	24	31	27	24	22	22
6	39	31	25	21	38	30	25	21	29	24	21	28	24	21	19	19
7	36	28	22	18	35	27	22	18	26	22	18	25	21	18	17	17
8	33	25	20	16	32	25	20	16	24	19	16	23	19	16	15	15
9	31	23	18	15	30	23	18	14	22	17	14	21	17	14	13	13
10	29	21	16	13	28	21	16	13	20	16	13	20	16	13	12	12

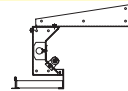

Total Luminaire Optical Efficiency = 58.6%